

# User Guide

## Spectra Precision® FOCUS® 2 Series Total Station

Version 1.0  
Revision C  
March 2015



## Corporate Office

Spectra Precision  
10368 Westmoor Drive  
Westminster, CO 80021  
USA  
+1-720-587-4700 Phone  
888-477-7516 (Toll free in USA)  
www.spectraprecision.com

## Legal Notices

### Copyright and Trademarks

© 2014, Spectra Precision. All rights reserved. All trademarks are the property of their respective owners.

Spectra Precision, the Spectra Precision logo, FOCUS, and the FOCUS logo are trademarks or registered trademarks of Spectra Precision, registered in the United States and in other countries.

The Bluetooth word mark and logos are owned by the Bluetooth SIG, Inc. and any use of such marks by Spectra Precision is under license.

All other trademarks are the property of their respective owners.

### Release Notice

This is the March 2015 release (Revision C) of the *Spectra Precision FOCUS 2 Series Total Station User Guide*. It applies to version 1.0 of the Spectra Precision FOCUS 2 Series total station.

### Product Limited Warranty Information

For applicable product Limited Warranty information, please refer to the Limited Warranty Card included with this Spectra Precision product, or consult your Spectra Precision Authorized Distribution Partner.

# Safety

For your safety, read this instruction manual carefully and thoroughly before using the Spectra Precision® FOCUS® 2 Series total station. Although Spectra Precision products are designed for maximum safety, using them incorrectly or disregarding the instructions can cause personal injury or property damage.

You should also read the documentation for any other equipment that you use with a FOCUS 2 Series instrument.

**Note** – Always keep the manual near the instrument for easy reference.

## Warnings and cautions

The following conventions are used to indicate safety instructions:



---

**WARNING** – Warnings alert you to situations that could cause death or serious injury.

---



---

**CAUTION** – Cautions alert you to situations that could cause injury or property damage.

---

Always read and follow the instructions carefully.

## Warnings

Before using the instrument, read the following warnings and follow the instructions that they provide:



---

**WARNING** – Never look at the sun through the telescope. If you do, you may damage or lose your eyesight.

---



---

**WARNING** – FOCUS 2 Series instruments are not designed to be explosion-proof. Do not use the instrument in coal mines, in areas contaminated with coal dust, or near other flammable substances.

---



---

**WARNING** – Never disassemble, modify, or repair the instrument yourself. If you do, you may receive electric shocks or burns, or the instrument may catch fire. You may also impair the accuracy of the instrument.









---



---

**WARNING** – Use **only** the battery charger and AC adapter that are supplied with the instrument. Do **not** use any other charger or you may cause the battery pack to catch fire or rupture.











---

- 
-  **WARNING** – Remove the on-board battery from the instrument and connect it to the battery charger. When the indicator lamp on the battery charger is red, the recharging process has begun. When charging is complete (indicator lamp turns green), disconnect the charger from its power source.
- 
-  **WARNING** – When the indicator lamp does not light after connecting the battery and charger, either the battery or the charger may be damaged. Please contact your local distributor.
- 
-  **WARNING** – Before removing the battery from the instrument, make sure that the power is turned off. Otherwise, the instrument may be damaged.
- 
-  **WARNING** – Do not cover the battery charger and AC adapter while the battery pack is being recharged. The charger must be able to dissipate heat adequately. Coverings such as blankets or clothing can cause the charger to overheat.
- 
-  **WARNING** – Avoid recharging the battery pack in humid or dusty places, in direct sunlight, or near heat sources. Do not recharge the battery pack when it is wet. If you do, you may receive electric shocks or burns, or the battery pack may overheat or catch fire.
- 
-  **WARNING** – Take care not to short circuit the contacts. Short circuits can cause the battery pack to catch fire or burn you.
- 
-  **WARNING** – Never burn or heat the battery. Doing so may cause the battery to leak or rupture. A leaking or ruptured battery can cause serious injury.
- 
-  **WARNING** – Before storing the battery pack or battery charger, cover the contact points with insulation tape. If you do not cover the contact points, the battery pack or charger may short circuit, causing fire, burns, or damage to the instrument.
- 
-  **WARNING** – The battery is not itself waterproof. Do not get the battery wet when it is removed from the instrument. If water seeps into the battery, it may cause a fire or burns.
- 

## Cautions

Before using the instrument, read the following cautions and follow the instructions that they provide:

- 
-  **CAUTION** – Use of controls, adjustments, or performance of procedures other than those specified herein may result in hazardous radiation exposure.
-

- 
-  **CAUTION** – The tips of the tripod ferrules are very sharp. When handling or carrying the tripod, take care to avoid injuring yourself on the ferrules.
- 
-  **CAUTION** – Before carrying the tripod or the instrument in the carrying case, check the shoulder strap and its clasp. If the strap is damaged or the clasp is not securely fastened, the carrying case may fall, causing personal injury or instrument damage.
- 
-  **CAUTION** – Before setting up the tripod, make sure that no-one's hands or feet are underneath it. When the legs of the tripod are being driven into the ground, they could pierce hands or feet.
- 
-  **CAUTION** – After mounting the instrument on the tripod, securely fasten the thumb screws on the tripod legs. If the thumb screws are not securely fastened, the tripod may collapse, causing personal injury or instrument damage.
- 
-  **CAUTION** – After mounting the instrument on the tripod, securely fasten the clamp screw on the tripod. If the clamp screw is not securely fastened, the instrument may fall off the tripod, causing personal injury or instrument damage.
- 
-  **CAUTION** – Securely fasten the tribrach clamp knob. If the knob is not securely fastened, the tribrach may come loose or fall off when you lift the instrument, causing personal injury or instrument damage.
- 
-  **CAUTION** – Do not stack objects on the plastic carrying case, or use it as a stool. The plastic carrying case is unstable and its surface is slippery. Stacking or sitting on the plastic carrying case may cause personal injury or instrument damage.
- 
-  **CAUTION** – The system in the instrument may stop functioning in order to avoid any errors in measurement when the instrument detects strong electromagnetic wave(s). If this is the case, turn off the instrument and remove the source of the electromagnetic wave(s). Then turn on the instrument to resume the work.
- 
-  **CAUTION** – Rechargeable batteries may be recharged 300 to 500 times.
- 
-  **CAUTION** – Complete discharge of the battery may shorten its service life.
- 
-  **CAUTION** – In order to get the maximum service life, be sure to recharge it at least once a month.
-

# Nickel-metal Hydride (NiMH) batteries

This product has a built-in NiMH battery.



---

**WARNING** – Do not disassemble, mutilate, or puncture the NiMH battery. A damaged battery can cause an explosion or fire, releasing hazardous chemicals, and can result in personal injury and/or property damage.

To prevent injury or damage:

- Do not attempt to replace the battery. For a battery replacement, contact your Spectra Precision dealer. There are no serviceable parts inside.
  - Do not expose the battery to temperatures of above 60 °C (140 °F) or store the battery pack at temperatures above 60 °C (140 °F) for extended periods.
  - Do not immerse the battery in water.
  - Do not use or store the battery inside a vehicle during hot weather.
- 



---

**WARNING** – If the NiMH battery is damaged or appears to be leaking, handle it with extreme care. Battery fluid is corrosive, and contact with it can result in personal injury and/or property damage.

To prevent injury or damage:

- If you come in contact with the electrolyte, wash the exposed area with soap and water.
  - If the electrolyte make contacts with your eye, immediately rinse the eye with water for 15 minutes and seek medical attention. Do not rub your eyes!
- 



---

**WARNING** – Charge and use the rechargeable NiMH battery only in strict accordance with the instructions. Charging or using the battery in unauthorized equipment can cause an explosion or fire, and can result in personal injury and/or equipment damage.

To prevent injury or damage:

- Do not charge or use the battery if it appears to be damaged or leaking.
  - Do not charge the battery pack if the ambient temperature exceeds 45 °C (113 °F) or is below 0 °C (32 °F).
  - Charge the battery only in a Spectra Precision product that is specified to charge it. Ensure that you follow all instructions that are provided with the battery charger.
  - Discontinue charging a battery that gives off extreme heat or a burning odor.
  - Use the battery only in Spectra Precision equipment that is specified to use it.
  - Use the battery only for its intended use and according to the instructions in the product documentation.
-

# Laser safety

The FOCUS 2 instrument is a Class 3R Laser Product in accordance with: IEC60825-1, Am2 (2001): “Safety of Laser Products”.

Use of the Laser Class 3R equipment can be dangerous.

Precautions: To counteract hazards, it is essential for all users to pay careful attention to the safety precautions and control measures specified in the standard IEC60825-1 (2001-08) resp. EN60825-1:1994 + A11:1996 + A2:2001, within the **hazard distance**<sup>1</sup>; particularly as described in this document.



---

**WARNING** – Only qualified and trained persons should be assigned to install, adjust and operate the laser equipment.

---



---

**WARNING** – Areas in which these lasers are used should be posted with an appropriate laser warning sign.

---



---

**WARNING** – Precautions should be taken to ensure that persons do not look directly, with or without an optical instrument, into the beam.

---



---

**WARNING** – The laser beam should be terminated at the end of its useful beam path and should in all cases be terminated if the hazardous beam path extends beyond the limit (**hazard distance**<sup>1</sup>) of the area in which the presence and activities of personnel are monitored for reasons of protection from laser radiation.

---



---

**WARNING** – Laser beam path should be located well above or below eye level wherever practicable.

---



---

**WARNING** – When the laser product is not used, it should be stored in a location where unauthorized personnel cannot gain access.

---



---

**WARNING** – Do NOT turn the class 3R laser beam to mirror like specular surfaces; for instance, prisms, metal surfaces or windows, even unintentionally. Special precautions should be taken to ensure eliminating such situations.

---

<sup>1</sup>. The hazard distance is the distance from the laser at which beam irradiance or radiant exposure equals the maximum permissible value to which personnel may be exposed without being exposed to health risk.

Table 1.1 Specifications for laser emission

<b>Laser pointer</b>	
Wave length	620 to 690 nm
Output power	CW $P_o \leq 4.75$ mW
<b>Distance meter in Reflectorless mode</b>	
Wave length	620 to 690 nm
Output power	$P_p \leq 8.75$ mW $P_o \leq 4.75$ mW
Pulse	1.2 nsec/400 MHz - 1.6 nsec/320 MHz
<b>Distance meter in Prism mode</b>	
Wave length	620 to 690 nm
Output power	$P_p \leq 0.037$ mW $P_o \leq 0.02$ mW
Pulse	1.2 nsec/400 MHz - 1.6 nsec/320 MHz

Table 1.2 Conforming standards

<b>E.U.</b>	EN60825-1/Am.2 : 2001 (IEC60825-1/Am.2 : 2001) : class 3R
<b>USA</b>	FDA21CFR Part 1040 Sec.1040.10 and 1040.11 (except for deviations pursuant to Laser Notice No.50, dated June 24, 2007)

## Labels





# Contents

<b>Safety</b> . . . . .	<b>3</b>
Warnings and cautions . . . . .	3
Warnings . . . . .	3
Cautions . . . . .	4
Nickel-metal Hydride (NiMH) batteries . . . . .	6
Laser safety . . . . .	7
Labels . . . . .	8
<b>1 Introduction</b> . . . . .	<b>13</b>
Parts of the instrument . . . . .	14
Accessories . . . . .	15
Display . . . . .	16
Keypad . . . . .	17
Softkeys . . . . .	17
Symbols . . . . .	19
Illumination and sound . . . . .	20
Auto power off . . . . .	21
<b>2 Preparation</b> . . . . .	<b>22</b>
Unpacking and packing the instrument . . . . .	23
Unpacking . . . . .	23
Packing . . . . .	23
Charging the battery pack . . . . .	23
Applying power . . . . .	24
Charging a battery . . . . .	25
Detaching and reattaching the battery pack . . . . .	25
Detaching the battery pack . . . . .	25
Inserting the battery pack . . . . .	25
Battery power remaining indicator . . . . .	26
Setting up the tripod . . . . .	26
Centering . . . . .	27
Centering using the optical plummet . . . . .	27
Centering using a plumb bob . . . . .	28
Leveling . . . . .	29
Sighting . . . . .	31
Setting the measurement mode . . . . .	32
Measurement with a prism . . . . .	32
Measurement in Reflectorless mode . . . . .	32
Reflector prisms . . . . .	33
Mounting and dismounting the instrument from the tribrach . . . . .	33
Dismounting . . . . .	33
Mounting . . . . .	34
Face-1/Face-2 measurements . . . . .	35
<b>3 Getting Started</b> . . . . .	<b>36</b>
Input modes . . . . .	37
Entering characters . . . . .	37
Editing characters . . . . .	37
Entering a point name or number . . . . .	38
Entering an existing point . . . . .	38
Entering a new point . . . . .	38
Specifying a wildcard (*) . . . . .	38
Entering a point from the point list . . . . .	39

Entering a point from the stack . . . . .	39
Entering a point using a temporary coordinate . . . . .	40
Recording an instant measurement . . . . .	41
<b>4 Routine Measurements . . . . .</b>	<b>42</b>
EDM setting . . . . .	43
[HOT] key . . . . .	44
Changing the height of the target . . . . .	44
Setting the temperature and pressure . . . . .	44
Selecting a target set . . . . .	45
Entering a field note . . . . .	47
Starting a survey . . . . .	48
Angle measurement . . . . .	49
OSET. . . . .	49
Enter the horizontal angle . . . . .	49
Repeat angle measurement. . . . .	49
Face-1/Face-2 measurements . . . . .	51
Hold. . . . .	51
Quick codes . . . . .	52
<b>5 Applications. . . . .</b>	<b>53</b>
Station key . . . . .	54
Setting up a station with known points (coordinates) . . . . .	54
Multiple point resection. . . . .	58
Quick station . . . . .	61
Height transfer (determining station elevation). . . . .	62
Checking and resetting the backsight direction . . . . .	63
Stakeout key . . . . .	64
Stakeout by angle and distance. . . . .	64
Coordinates stakeout . . . . .	67
Partline stakeout. . . . .	69
RefLine stakeout . . . . .	70
Measuring offsets . . . . .	72
Measuring distance offsets . . . . .	72
Measuring angle offsets. . . . .	73
Two-prism pole . . . . .	74
+HA line. . . . .	74
Input HD . . . . .	75
Calculating a corner point. . . . .	76
Calculating a column . . . . .	77
Extending the slope distance . . . . .	77
Program Key . . . . .	78
Point refline . . . . .	78
Reference Arc . . . . .	79
Remote distance measurement . . . . .	80
Remote elevation measurement (REM) . . . . .	84
2-PT reference plane (V-plane) . . . . .	85
3-PT reference plane (S-Plane) . . . . .	86
Roads . . . . .	87
COD key. . . . .	98
DAT key . . . . .	99
USR 1/USR2 keys. . . . .	99
<b>6 Menu Key . . . . .</b>	<b>100</b>
Job . . . . .	101
Opening a job . . . . .	101
Creating a new job. . . . .	101
Deleting a job . . . . .	102
Setting the control job. . . . .	103

Displaying job Information . . . . .	103
Coordinate Geometry (COGO) calculations . . . . .	104
Inverse calculating . . . . .	104
Azimuth and Distance (AZ&Dist) . . . . .	106
Calculate area . . . . .	108
Line and offset . . . . .	109
Entering coordinates manually . . . . .	110
Settings . . . . .	110
Data . . . . .	112
RAW data . . . . .	112
Coordinate data . . . . .	116
Station records . . . . .	118
Point name list and code list . . . . .	119
Communication . . . . .	121
Downloading data from the total station to a computer . . . . .	121
Uploading coordinate data . . . . .	125
Uploading a point name list or code list . . . . .	127
1 Sec Keys . . . . .	128
[MSR] key settings . . . . .	128
[DSP] key settings . . . . .	128
[USR] key settings . . . . .	129
[S-O] key settings . . . . .	129
[DAT] key settings . . . . .	130
Date and time . . . . .	131
Format . . . . .	131
Information . . . . .	132
<b>7 Checking and Adjustment . . . . .</b>	<b>133</b>
Adjusting the electronic level . . . . .	134
Checking and adjusting the circular level . . . . .	134
Checking and adjusting the optical plummet . . . . .	134
Zero point errors of vertical scale and horizontal angle corrections . . . . .	135
Checking . . . . .	135
Adjusting . . . . .	135
Checking the instrument constant . . . . .	136
Checking the laser pointer . . . . .	137
<b>8 Specifications . . . . .</b>	<b>138</b>
Distance measurement . . . . .	139
Angle measurement . . . . .	139
Telescope . . . . .	140
Tilt sensor . . . . .	140
Communications . . . . .	140
Power . . . . .	140
General . . . . .	141
Environmental . . . . .	141
<b>9 Error Messages . . . . .</b>	<b>142</b>
E001 . . . . .	143
E002 . . . . .	143
E003 . . . . .	143
E004 . . . . .	143
E005 . . . . .	143
E006 . . . . .	143
E007 . . . . .	143
E031 . . . . .	144
E032 . . . . .	144
E033 . . . . .	144
E034 . . . . .	144

E035. . . . .	144
E036. . . . .	144
E037. . . . .	145
E038. . . . .	145
E33 . . . . .	145
<b>A Design Road Line Data . . . . .</b>	<b>.146</b>
Raw data . . . . .	147
Coordinate data . . . . .	148
Code list . . . . .	148
Horizontal line . . . . .	149
Vertical curve. . . . .	149
<b>B Calculate Road Alignment . . . . .</b>	<b>.150</b>
Road alignment elements. . . . .	151
Enter the alignment data . . . . .	151
Calculating road alignment elements . . . . .	153
Length of transition curve . . . . .	153
Deflection angle . . . . .	154
Transition coordinates. . . . .	154
Shift value ?R. . . . .	155
Spiral transition coordinates . . . . .	155
Tangent distance. . . . .	155
Coordinate KA1 . . . . .	156
Arc length. . . . .	156
Coordinate KA2 . . . . .	157
Coordinates BC, EC which is ARC (IP1,IP2,EP) . . . . .	157

# Introduction

## In this chapter:

- Parts of the instrument
- Accessories
- Display
- Keypad
- Softkeys
- Symbols
- Illumination and sound
- Auto power off

Thank you for purchasing this product.

Before you operate a FOCUS 2 Series total station, read this manual carefully. In particular, pay attention to the warnings and cautions that appear in the Safety section at the front of the manual.

# Parts of the instrument

Figure 1.1 shows the main parts of the FOCUS 2 Series total station.



Figure 1.1 FOCUS 2 Series total station: Face 1

# Accessories

The following items are supplied with the instrument.

Item	Quantity
Carrying case	1
Total station main body	1
Battery	2
Charger and adapter cable	1
Plumb bob	1
Adjusting pin	2
Fur brush	1
Screw driver	1
Hexagon wrench	2
Cloth	1
Dryer	1
User manual	1
Warranty certificate	1
Rain cover	1
Software CD	1

# Display

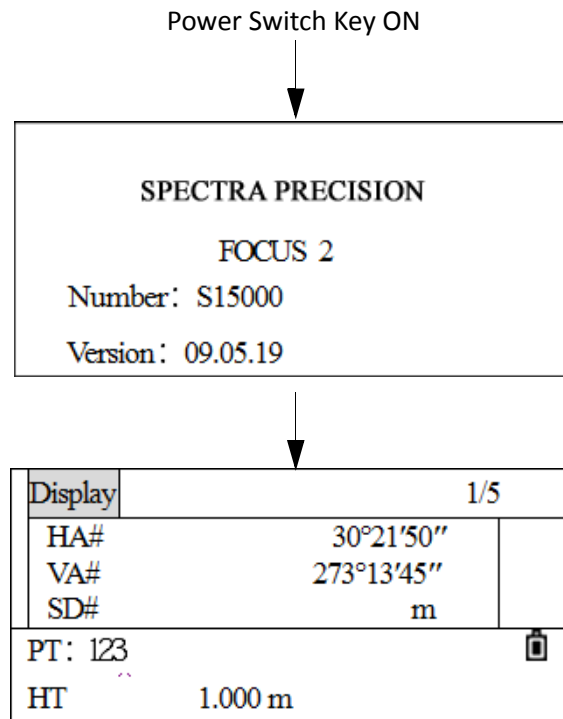







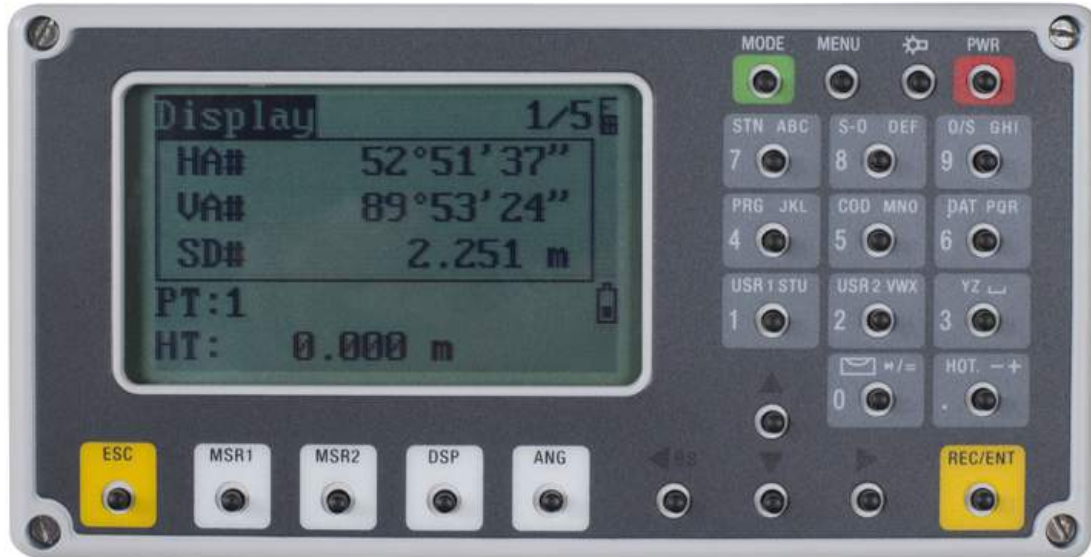

- Confirm the battery power shown on the display. Replace it with another charged battery or change it when battery level is low. See Battery power remaining indicator, page 26.

















# Keypad







## Softkeys

Key	Function										
	Power ON/OFF.										
	Illumination ON/OFF.										
	Displays the Function menu. <div style="border: 1px solid black; padding: 5px; margin-top: 10px;"> <p style="text-align: center;">----- Menu -----</p> <table style="width: 100%; border-collapse: collapse;"> <tr> <td style="width: 50%;">1. Job</td> <td style="width: 50%;">6. 1 Sec.</td> </tr> <tr> <td>2. Cogo</td> <td>7. Adjust</td> </tr> <tr> <td>3. Set</td> <td>8. Time</td> </tr> <tr> <td>4. Data</td> <td>9. Format </td> </tr> <tr> <td>5. Comm</td> <td>10. Info</td> </tr> </table> </div>	1. Job	6. 1 Sec.	2. Cogo	7. Adjust	3. Set	8. Time	4. Data	9. Format 	5. Comm	10. Info
1. Job	6. 1 Sec.										
2. Cogo	7. Adjust										
3. Set	8. Time										
4. Data	9. Format 										
5. Comm	10. Info										
	Changes the mode of input: alphabetic/numeric; launches quick code mode in the Basic Measurement screen.										
	Accepts the input or records the data; In the Basic Measurement screen, press it for 1 second to select the data saving mode (CP or SS).										
	Returns to the last screen; cancels the data input.										

Key	Function
	Measures the distance based on the measure mode settings for the key. Press it for 1 second to view and change the measurement mode.
	Measures the distance based on the measure mode settings for the key. Press it for 1 second to view and change the measurement mode.
	Key to advance through the different display screens. Press it for 1 second to launch customizing options.
	Displays the <i>Angle Measuring</i> menu; sets the horizontal angle to zero; input the horizontal angle, repetition angle measuring; F1/F2 angle measuring; holds the horizontal angle.
	Displays the <i>Station Setup</i> menu; inputs number 7 and letters A, B, and C.
	Displays the <i>Stakeout</i> menu, press it for 1 second to display the settings for stakeout; inputs number 8 and letters D, E, and F.
	Displays the <i>Offset Point Measurement</i> menu; inputs number 9 and letters G, H, and I.
	Displays the <i>Programs</i> menu; inputs number 4 and letters J, K, and L.
	Opens a window where you can enter a code. The default code value is the last code entered. Inputs number 5 and letters M, N, and O.
	Displays RAW, XYZ, or STN data, depending on the setting. Inputs number 6 and letter P, Q, and R.
	Executes the function that is assigned to the USR1 Key. Inputs number 1 and letters S, T, and U.
	Executes the function that is assigned to the USR2 Key. Inputs number 2 and letters V, W, and X.
	Inputs number 3 and letters Y, Z, and Space.
	Displays the HOT menu. Inputs -, + and .
	Displays the electronic bubble indicator; inputs *, /, = and 0.

# Symbols

The below symbols indicate specific working status (depending on the version of the software).

Symbol	Description
	Please select via left/right key.
	To display each screen via up/down key.
	Indicates that several pages are selectable. Press to turn the page.
	Indicates that the telescope (alidade) is on Face1 or Face 2. F1: Face 1 Measurement: the vertical circle is on the left of telescope when measuring. F2: Face 2 Measurement: the vertical circle is on the right of telescope when measuring.

The below symbols are displayed on the screen:





Symbol	Description
HA	Horizontal angle
VA	Vertical angle
SD	Slope distance
AZ	Azimuth
HD	Horizontal distance
VD	Vertical distance
HL	Horizontal angle Left = (360°-HA)
V%	Slope ratio (or Percent of grade)
N	Northing coordinate
E	Easting coordinate
Z	Elevation coordinate
PT	Point
HT	Height of target
CD	Code
PPM	Atmospheric correction value
P1	Point 1
P2	Point 2
HI	Height of Instrument
BS	Backsight Point
ST	Station (Instrument) setup point
	1. A “#” displayed behind these symbols means the automatic tilt correction is not activated. 2. A “d” displayed in front of these symbols, means it is a difference value.

## Illumination and sound

Press the illumination key (  ) to turn the LCD backlight ON and OFF.

Press the illumination key for 1 second to open a 5-switch window displayed above. Use the 5-switch window to adjust lighting, sound setting and contrast of the screen.

With the window opened as above, press ▲ , ▼ (or press ①, ②, ③, ④, ⑤ corresponding to the items) to choose the settings for the switch. When an item is selected, the function corresponding to the key can be launched ON/OFF by pressing the corresponding number.

Display		1 
HA#	30°21'50"	2 
VA#	273°13'42"	3 
SD#		4 
PT: 123		5 
HT	1.000 m	

1. Press for 1 second to open the window of setting LCD light, sound, contrast, and laser pointer.
2. When the current cursor is on the LCD light icon, press **1** to toggle the light on and off.

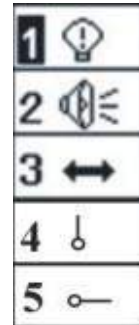

LCD backlight ON



LCD backlight OFF

3. Press **2** or ▼ to move to the Sound icon. Press **2** to toggle the sound on and off.



Sound ON



Sound OFF

4. Press **3** or ▼ to move to the contrast icon. Press **3** continuously to adjust the contrast level.
5. Press **4** or ▼ to move to the laser plummet icon. Press **4** to turn on or off the laser plummet<sup>1</sup>.
6. Press **5** or ▼ to move to the laser pointer item. Press **5** to turn on or off the laser pointer.

## Auto power off

The system-default time for Auto Power OFF is 30 minutes. If no key is pressed within this time, the instrument will be switched off to save the battery.

<sup>1</sup>. The laser plummet option is not available in the FOCUS 2 Series total station.

# Preparation

## In this chapter:

- Unpacking and packing the instrument
- Charging the battery pack
- Detaching and reattaching the battery pack
- Battery power remaining indicator
- Setting up the tripod
- Centering
- Leveling
- Sighting
- Setting the measurement mode
- Reflector prisms
- Mounting and dismounting the instrument from the tribrach
- Face-1/Face-2 measurements

# Unpacking and packing the instrument

*Note – Handle the total station carefully to protect it from shocks and excessive vibration.*

## Unpacking

To unpack the instrument, place the case gently with the cover upward, unlock the case, open the lid and take out the instrument.

## Packing

Replace the telescope lens cap, place the instrument into the case with the vertical clamp and circular level upwards (objective lens pointing towards the tribrach), and lightly tighten the vertical clamp. Close the lid and lock the case.

## Charging the battery pack

Before charging the battery pack, read the warnings (also listed in the Safety section at the front of this manual) and the following notes.



**WARNING –** Do not damage the rechargeable Ni-MH battery. A damaged battery can cause an explosion or fire, and can result in personal injury and/or property damage.

To prevent injury or damage:

- Do not use or charge the battery if it appears to be damaged. Signs of damage include, but are not limited to, discoloration, warping, and leaking battery fluid.
- Do not expose the battery to fire, high temperature, or direct sunlight.
- Do not immerse the battery in water.
- Do not use or store the battery inside a vehicle during hot weather.
- Do not drop or puncture the battery.
- Do not open the battery or short-circuit its contacts.



**WARNING –** Avoid contact with the rechargeable Ni-MH battery if it appears to be leaking. Battery fluid is corrosive, and contact with it can result in personal injury and/or property damage.

To prevent injury or damage:

- If the battery leaks, avoid contact with the battery fluid.
- If battery fluid gets into your eyes, immediately rinse your eyes with clean water and seek medical attention. Do not rub your eyes!
- If battery fluid gets onto your skin or clothing, immediately use clean water to wash off the battery fluid.

---

 **WARNING** – Charge and use the rechargeable Ni-MH battery only in strict accordance with the instructions. Charging or using the battery in unauthorized equipment can cause an explosion or fire, and can result in personal injury and/or equipment damage.

To prevent injury or damage:

- Do not charge or use the battery if it appears to be damaged or leaking.
  - Charge the Ni-MH battery only in a product that is specified to charge it. Be sure to follow all instructions that are provided with the battery charger.
  - Discontinue charging a battery that gives off extreme heat or a burning odor.
  - Use the battery only in equipment that is specified to use it.
  - Use the battery only for its intended use and according to the instructions in the product documentation.
- 

 **WARNING** – To charge the battery pack, use only the battery charger and AC adapter that are supplied with the instrument. Do NOT use any other charger or you may cause the battery pack to catch fire or rupture. The enclosed battery pack cannot be used with other chargers.

---

 **WARNING** – Do not cover the battery charger and AC adapter while the battery pack is being recharged. The charger must be able to dissipate heat adequately. Coverings such as blankets or clothing can cause the charger to overheat.

---

 **WARNING** – Avoid recharging the battery pack in humid or dusty places, in direct sunlight, or near heat sources. Do not recharge the battery pack when it is wet. If you do, you may receive electric shocks or burns, or the battery pack may overheat or catch fire.

---

 **WARNING** – Take care not to short circuit the contacts. Short circuits can cause the battery pack to catch fire or burn you.

---

 **WARNING** – Never burn or heat the battery. Doing so may cause the battery to leak or rupture. A leaking or ruptured battery can cause serious injury.

---

 **WARNING** – Before storing the battery pack or battery charger, cover the contact points with insulation tape. If you do not cover the contact points, the battery pack or charger may short circuit, causing fire, burns, or damage to the instrument.

---

 **WARNING** – The battery is not itself waterproof. Do not get the battery wet when it is removed from the instrument. If water seeps into the battery, it may cause a fire or burns.

---

## Applying power

Plug in the charger to the supplied AC adapter to turn the unit on.



## Charging a battery



---

**CAUTION** – Rechargeable batteries may be recharged 300 to 500 times.

---



---

**CAUTION** – Complete discharge of the battery may shorten its service life.

---



---

**CAUTION** – In order to get the maximum service life, ensure that the batteries are recharged at least once a month.

---

- Remove the on-board battery from the instrument and connect it to the battery charger. The adjacent charge indicator will illuminate red when charging is in progress. The charge indicator will change to green when charging is complete. Disconnect the charger from the power source.
- Charging may take about 4 hours if the battery was normally discharged.
- Ni-MH batteries should not be charged at temperatures above 40 °C to 45 °C.
- If the charge indicator(s) does not light after connecting the battery and charger, the battery or the charger may be damaged. Please contact your authorized service center for assistance.

## Detaching and reattaching the battery pack

### Detaching the battery pack



---

**CAUTION** – Before removing the battery from the instrument, make sure that the power is turned off. Otherwise, the instrument may be damaged.

---



---

**CAUTION** – Avoid touching the contacts on the battery pack.

---

1. If the instrument is turned on, press **[PWR]** to turn it off.
2. Squeeze the battery pinch clamps toward each other and slide the battery from the instrument.

### Inserting the battery pack

1. Squeeze the battery pinch clamps and insert the battery smoothly into the battery box.
2. Release the clamps and enable the battery to snap into place.



---

**CAUTION** – If the battery box cover is not inserted correctly, this could adversely affect the watertightness of the instrument.

---





## Battery power remaining indicator

The battery power remaining indicator displays the current power condition.

The battery operating time varies depending on the environmental conditions such as ambient temperature, how long the battery has been charged, the number of times of charging and discharging. It is recommended to charge the battery before use or to prepare spare, fully charged batteries.

The battery power remaining display shows the power level regarding the current measurement mode. The distance measurement mode consumes more power than angle measurement mode. Pay particular attention to this when switching angle measurement mode to distance measurement mode, because insufficient battery power may lead to interrupted operation. Battery power status should always be checked prior to outdoor operation.

Display	1/5	
HA#	30°21'50"	
VA#	273°13'42"	
SD#	m	
PT: 123		
HT	1.000 m	

Icon	Description
	Measurement can be launched.
	Measurement can be launched.
	Measurement can be launched.
	Low battery. It should be recharged.
	Unable to measure. The battery must be recharged.

When the measurement mode is changed, the battery power does not immediately update. The battery power indicating system shows the general status but not the instantaneous change of battery power.

## Setting up the tripod

Mount the instrument to the tripod. Level and center the instrument precisely to ensure the best performance.



**CAUTION** – The tops of the tripod ferrules are very sharp. When handling or carrying the tripod, take care to avoid injuring yourself on the ferrules.

1. Open the tripod legs enough for the instrument to be stable.
2. Locate the tripod directly over the station point. To check the tripod's position, look through the center hole in the tripod head.
3. Firmly press the tripod ferrules into the ground.
4. Level the top surface of the tripod head by adjusting the height of the tripod legs.

5. Securely fasten the thumb screws on the tripod legs.
6. Place the instrument on the tripod head.
7. Insert the tripod mounting screw into the center hole of the base plate of the instrument.
8. Tighten the tripod mounting screw.

**Note** – Do not carry the instrument while it is attached to a tripod.

## Centering

When you center the instrument, you align its central axis precisely over the station point. To center the instrument, you can either use the optical plummet (see page 27) or a plumb bob (see page 28).

### Centering using the optical plummet

**Note** – If you require high accuracy, check and adjust the optical plummet before you center the instrument. For detailed instructions, see *Checking and adjusting the optical plummet*, page 134.

To center the instrument using the optical plummet:

1. Set up the instrument on the tripod. See *Setting up the tripod*, page 26.
2. While looking through the optical plummet, align the center mark of the reticle with the station point. To do this, turn the leveling screws until the center mark of the reticle is directly over the image of the station point.
3. While supporting the tripod head with one hand, loosen the tripod leg clamps and adjust the lengths of the legs until the air bubble is in the center of the circular level.
4. Tighten the tripod leg clamps.
5. Use the circular vial to roughly level the instrument. See page 29.
  - a. Adjust the length of three legs of tripod to make the circular vial bubble of the instrument centered.
6. Use the plate level vial to level the instrument accurately.
  - a. Rotate the instrument horizontally by loosening the Horizontal Clamp and place the plate vial parallel to the line connecting leveling screw A and B, and then bring the bubble to the center of the plate vial by turning the leveling screws A and B.
  - b. Rotate the instrument 90°, making it perpendicular to the connecting line of level screws A and B. Turn level screw C to make the bubble of the plate vial centered.
7. Precisely center and level the instrument.

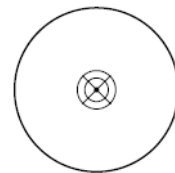

- a. Looking through the optical plummet, reconfirm the station point image is still centered in the reticle mark.
- b. If a slight displacement of the station point is detected, loosen the tripod mounting screw and correct the instrument's positioning with direct movement (not rotational). If the displacement of the station point is major, repeat this procedure from Step 2.

## Centering using a plumb bob

1. Set up the instrument on the tripod. See Setting up the tripod, page 26.
2. Hang the plumb line on the hook of the tripod mounting screw.
3. Adjust the length of the plumb line so that the tip of the plumb bob is at the height of the station point.
4. Loosen the tripod mounting screw slightly.
5. Using both hands to support the outer side of the tribrach, carefully slide the instrument about on the tripod head until the tip of the plumb bob is positioned over the exact center of the station point.

**Note** – *To confirm that the instrument is precisely aligned, check its position from two directions at right angles to each other.*

# Leveling

As the tilt sensor is activated, automatic correction of vertical angle for mislevelment is displayed.

To ensure a precise angle measurement, the tilt sensor must be activated. The display can be used to fine level the instrument.

If the instrument has not been roughly leveled, the screen displays that the instrument is out of the automatic correction range, and that it needs to be leveled manually.

The instrument compensates the vertical angle reading as well as both vertical and horizontal angle reading due to inclination of the vertical axis in the X direction and XY directions (known as *dual-axis compensation*).

1. Press  to open the automatic compensation function. The tilt compensation value is displayed.

If the value is within  $\pm 3.5'$ , it indicates that it is in the automatic compensation range of the vertical circle. Press **[ESC]** to return to measurement function. If it is beyond  $\pm 3.5'$ , it means that it needs to be leveled manually.

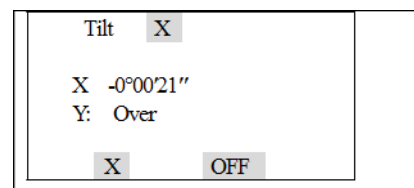

2. Press **[MSR2]** to shift the compensation mode to dual-axis compensation.
3. After leveling, press **[ESC]** to return to previous status.
4. To close automatic compensation, press **[OFF]**.

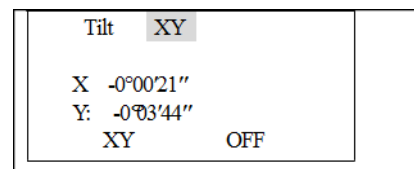

When the instrument is placed on an unstable surface or in windy weather conditions, the display of the vertical angle may be unstable. You can switch off the auto tilt correction function for vertical angle.

If the auto correction mode is ON and the instrument has not been leveled, the program will state that the instrument must be leveled before being able to enter other functions.

When you level the instrument, you make the vertical axis of the instrument exactly vertical. To level the instrument, use the electronic level. In the leveling work, always set the instrument in the Face 1 direction (see Figure 1.1 on page 14).

To level the instrument:

1. Roughly level the instrument using the circular vial:
  - a. Turn the leveling screw **1** and **2** to move the bubble in the circular level vial, in which case the bubble is positioned on a line perpendicular to a line running through the center of the two leveling screws being adjusted.
  - b. Turn the leveling screw **3** to move the bubble to the center of the circular vial:

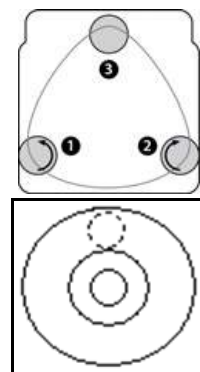

2. Precisely level the instrument using the plate vial:

- a. Rotate the instrument horizontally by loosening the Horizontal Clamp and place the plate level vial parallel to the line connecting leveling screws **1** and **2**, and then bring the bubble to the center of the plate vial by turning the leveling screws **1** and **2**.

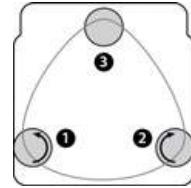

- b. Rotate the instrument 90° around its vertical axis and turn the remaining leveling screw **3** to center the bubble once more.
3. Use leveling screw **1** to move the bubble into the center of the electronic level.
4. Repeat Step 2 for each 90° rotation of the instrument and check that the bubble is correctly centered in all directions.

# Sighting

When the instrument is sighted, the telescope is aimed at the target, the target image is focused upon and the image is then aligned with the center cross-hairs of the telescope reticle.

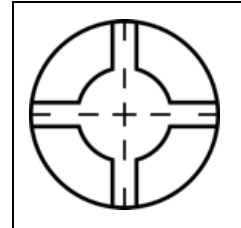

Sighting the instrument:

1. Diopter adjustment:
  - a. Point the telescope at a blank area like a wall, the sky, or a sheet of paper.



**WARNING** – Never look at the sun through the telescope. If you do, you may damage or lose your eyesight.

- b. While sighting through the eyepiece, rotate the diopter ring until the reticle crosshairs are brought into sharp, clear focus.
2. Elimination of parallax:

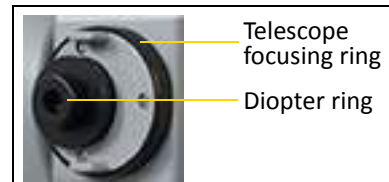

- a. Aim the telescope at the target.
      - b. Rotate the focusing ring until the target image is in sharp focus on the reticle crosshairs.
      - c. Move your eye vertically and laterally to check whether the target image moves relative to the reticle crosshairs.  
If the target image does not move, there is no parallax.
      - d. If the target image does move, rotate the telescope focusing ring. Then repeat from Step c.
3. Target alignment:
  - To align the target accurately on the center crosshairs, carefully rotate the tangent screw as required.

## Setting the measurement mode

The FOCUS 2 Series total station has two measurement modes:

- Prism mode (Prism) – See Measurement with a prism, page 32.
- Reflectorless mode (N-Prism) – See Measurement in Reflectorless mode, page 32.

These modes can be changed at any time by holding down the **[MSR1]** or **[MSR2]** key for one second. For more information, see 1 Sec Keys, page 128.

To set the measurement mode depending on the target you want to measure, see the following table.

Target	Target setting
Prism, reflector sheet	Prism (Prism mode)
Other (reflective materials)	N-Prism (Reflectorless mode)

In some cases, you can measure another target that is not appropriate to the set measurement mode.

**Note** – The Focus 2 Series total station is Laser Class 3R in the Reflectorless mode and Laser pointer function, and Laser Class 1 in the Prism mode.



**CAUTION** – Do not sight the prism when the laser pointer is on.

## Measurement with a prism

Do not use a prism that is damaged, dirty, scratched, or chipped.

As the FOCUS 2 Series total station is extremely sensitive, multiple reflections on the prism surface can cause a loss in accuracy.

## Measurement in Reflectorless mode

The distance the FOCUS 2 Series total station can measure depends on the strength of the reflected signal from the target. Target reflectivity, condition, and color all affect the distance measured. Surfaces that have low reflectivity may not yield a measurement.

### Setting the prism constant

To do this, hold down **[MSR1]** or **[MSR2]** for one second. For more information, see 1 Sec Keys, page 128.

**Note** – If the prism constant is not 0 mm, then enter the prism constant value directly into the Const field. For example, if the prism constant is -30 mm, enter -30 mm into the Const field on the instrument.

```
<MSR1>
TGT: Prism
Const: -30mm
Mode: Fine[s]
Rec: All
```



 **Tip** – When you use the prism at a short distance, set the prism at a slight angle to the sighting axis, rather than completely square.

## Reflector prisms

When measuring distances using reflector prisms, a prism needs to be placed at the target place. Reflector systems come with single prism and triple prisms, which can be mounted in a tribrach onto a tripod or mounted onto a prism pole. Reflector systems can be self-configured by users according to the job.

## Mounting and dismounting the instrument from the tribrach

### Dismounting

If necessary, the instrument (including reflector prisms with the same tribrach) can be dismounted from the tribrach. Loosen the tribrach locking screw in the locking knob with a screwdriver. Turn the locking knob about 180° counter-clockwise to disengage anchor jaws, and remove the instrument from the tribrach.

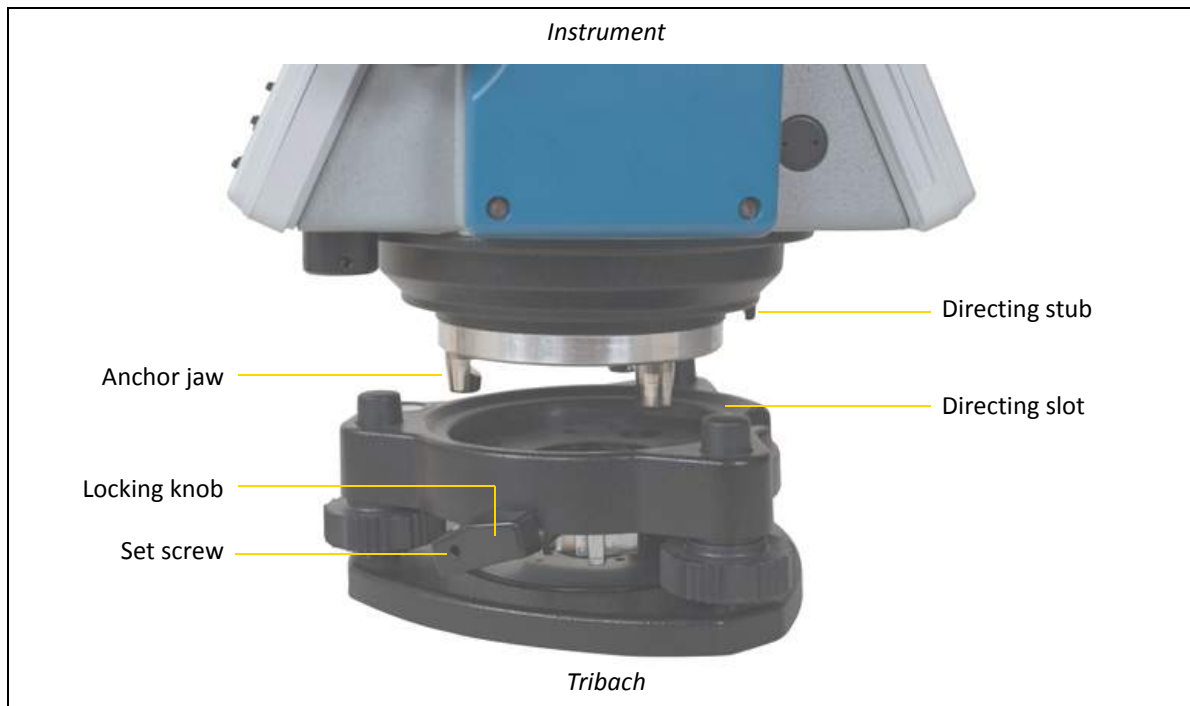

## Mounting

Insert the three anchor jaws into holes in the tribrach and line up the directing stub with the directing slot. Turn the locking knob about 180° clockwise and tighten the locking screw with a screwdriver.

## Face-1/Face-2 measurements

A measurement can be taken from either face of the instrument. To change the face, rotate the instrument 180° on its base, and rotate the telescope 180° within the standard.

By averaging the Face-1 and Face-2 measurement values, most constant mechanical errors can be cancelled out. Some errors, such as vertical axis error, cannot be cancelled out by averaging Face-1 and Face-2 measurements.

When rotating the telescope, take care not to catch a finger in the gap between the instrument's standard and the telescope.

A Face-1 measurement is made with the vertical circle positioned to the left of the telescope eyepiece. A Face-2 measurement is made with the vertical circle positioned to the right of the telescope eyepiece.



# Getting Started

**In this chapter:**

- Input modes
- Entering a point name or number

## Input modes

All characters can be entered in a data input field. The maximum length of character of a point ID or point number is 16.

Press  to delete one character to the left of the cursor.







When the data is wider than the screen, the data automatically moves to the left.



When an A is displayed on the upper right corner of the screen, letters can be entered using the keypad. When 1 is displayed, numbers can be entered. In any measurement screen or screens that need manual input, press  to shift between alpha mode and numeric mode.

In alpha mode, three letters are set using one key. Each key press displays the next letter for that key in the cursor.

The methods for Code (CD) input are; enter manually, select from a list and select from a stack. The operational methods are the same as that of entering a point.

## Entering characters

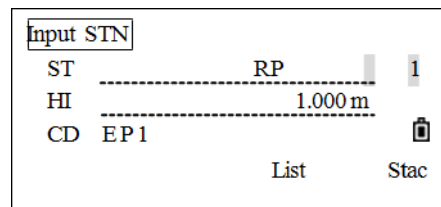
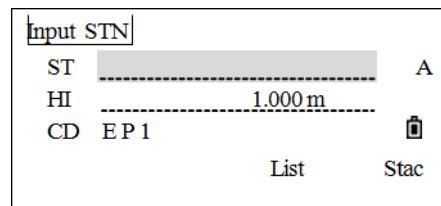

1. Ensure that the current input mode is alpha mode. If not, press .
2. Press  three times to enter **R**.
3. Press  once to enter **P**.
4. Press  to change to numeric mode.
5. Press  and .
6. Press  to confirm.

 **Tip** – If the point ID is wrong, press  and enter it again.



## Editing characters

Characters that have been entered can be edited.

1. Move the cursor to the item that needs to be edited, and press . The cursor stays on the first character and flashes.
2. Press  to move the cursor to the character that needs to be edited.
3. Enter the new character.
4. Press  to confirm. The cursor moves to the next item.

 **Tip** – Press  to delete the right character.

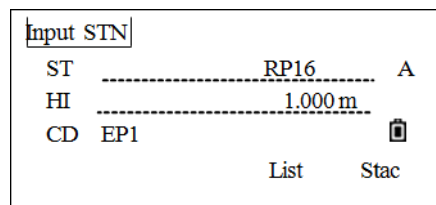

## Entering a point name or number

You can use numeric or alphanumeric names up to 16 characters long to identify points.

The default name for a new point is the last point name entered, with the last digit incremented. For example, if the last point name was A100, the default name for the next point is A101.

If the last character of the previous point name is alphabetic, the default point name is the last point name.

When the cursor is in a PT (point) field, there are several ways to specify a point, or enter coordinates.

### Entering an existing point

For example, to enter a point ID in the PT field:

1. Enter **PtID** in the PT field and then press **[REC/ENT]**.

The system searches for the point ID in internal memory. If this Point ID exists, its coordinate are displayed.

2. Press **[REC/ENT]** to return to the screen. The point is selected and the cursor moves to the next item.

N	.....	10.000 m	
E	.....	10.000 m	
Z	.....	10.000 m	
PT	AD1		
CD:	EP1		

### Entering a new point

1. When you enter a new point name or number, a coordinate input screen appears. Enter the point's coordinates in NE, NEZ, or elevation-only (Z) format.
2. Press **[REC/ENT]** to move to the next item.
3. Press **[REC/ENT]** on the CD field to store the point in the current job.

N	.....	10.000 m	
E	.....	10.000 m	
Z	.....	10.000 m	
PT	2		
CD	.....		
		List	Stac

### Specifying a wildcard (\*)

If you include an asterisk (\*) when you enter a point or code name, a list of points that match the entered text appears. For example:

Wildcard	Definition
*	All points of any length are found.
A	All points with exactly the pointID "A" are found.
A*	All points of any length starting with "A" are found (for example, A8, A71, ABDE)

Wildcard	Definition
*1	All points of any length with a "1" as the second character are found (for example, W1, F15, A1R)
A*1	All points of any length with an "A" as the first character and a "1" as the third character are found (for example, AD1, AR100, AS16).

1. In a PT item, insert a wildcard, for example "\*" and then press **REC/ENT**.
2. Use **▲** or **▼** to move the cursor to the point that you want to use. Then press **REC/ENT**.
3. If the **▲** or **▼** icons are displayed, use them to scroll up or down the list. Select the point and then press **REC/ENT**.

When you select a point from the list, its coordinates are displayed.

## Entering a point from the point list

1. To display a list of existing points, press the **List** softkey when the cursor is in the PT field. The PtID list appears.
2. Use **▲** or **▼** to move the cursor to the point that you want to use. Then press **REC/ENT**.
3. When you return to the point input screen, the selected point name is entered in the PT field. You can add digits or alphabetic characters if required. Press **REC/ENT** to confirm.
4. If the input PtID exists in internal memory, its coordinate will be displayed on the screen. Press **REC/ENT** to return.
5. If the input PtID does not exist, enter a coordinate and then press **REC/ENT** to move the cursor to the code (CD) item. Enter the code. Press **REC/ENT** to save and quit.

Return to the input PT screen. The cursor moves to the next item.

## Entering a point from the stack

The point stack is a list of recently used points. It shows the last 20 point names used, in chronological order from the last used to the first used.

1. To display the stack, press the **Stac** softkey when the cursor is in the PT field.
2. Use **▲** or **▼** to move the cursor to the point that you want to use. Press **▲** or **▼** to select the point and then press **REC/ENT**.

When you return to the point input screen, the selected point name is entered in the PT field, incremented by one. For example, if you selected the A098 point, A099 appears in the PT field. Press **[REC/ENT]**.

3. If the entered PtID exists in internal memory, its coordinate is displayed. Press **[REC/ENT]** to return.

N	-----	10.000 m	
E	-----	10.000 m	
Z	-----	5.000 m	
PT	1		
CD	EP1		

4. If the entered PtID does not exist, enter a coordinate and then press **[REC/ENT]** to move the cursor to the code (CD) item. Enter the code. Press **[REC/ENT]** to save and quit.

N	-----		
E	-----		
Z	-----		
PT	2		
CD	-----		

## Entering a point using a temporary coordinate

In some cases when entering a point ID, a temporary coordinate that does not need to be saved can be used.

To use a point without recording the coordinates, press **[REC/ENT]** in a PT field, without entering a point name. A coordinate input screen appears.

<b>[Input PT0]</b>			
PT	-----		1
HT	-----	1.000 m	
CD	-----		
		List	Stac

Enter the coordinate and then press **[REC/ENT]** to move to next item. Press **[REC/ENT]** when finished.

The input coordinates are used in the calculation. They are not saved in the database.

N	-----		
E	-----		
Z	-----		
*This Pt. not saved			



## Recording an instant measurement

To enter a point by recording an instant measurement:

1. Press the **Meas** softkey.

Input P1		
P1	-----	1
P2	-----	
Meas	List	Stac

An observation screen appears.

2. Press **[MSR1]** or **[MSR2]** to start a measurement. To change the height of the target, press the **HT** softkey.

After measuring, the point recording screen appears.

HA#	32°05'34"	
VA#	22°26'25"	
SD#		
HT	0.000 m	
*Sight Press [MSR]		
	HT	OK

3. Enter the point ID and CD, and press **[REC/ENT]** to record the result.

N	-----	10.000 m	
E	-----	10.000 m	
Z	-----	5.000 m	
PT	1		
CD	-----		
	List	Stac	

4. When the measurement is finished, press **[REC/ENT]**.

If there is alignment data in the internal memory, the point ID can be entered via the chainage value. For more information, see Station setup, page 94.

Input P1		
P1	<Coordinate measured>	1
P2	-----	
Meas	List	Stac

# Routine Measurements

## In this chapter:

- EDM setting
- **HOT** key
- Starting a survey
- Angle measurement
- Quick codes

After correctly setting up and starting the instrument, it is immediately ready to take measurements.

All shown displays are for illustrative purposes only and may vary slightly according to the software version. The following example shows a possible measuring display:

Display	1/5
HA#	30°21'50"
VA#	273°13'45"
SD	m
PT: 123	
HT	1.000 m

## EDM setting

Press **[MSR1]** or **[MSR2]** for one second to enter each measurement function. The **[MSR2]** measurement mode setting is the same as **[MSR1]**. When pressing **[MSR1]** or **[MSR2]**, the system activates the corresponding measurement mode to measure.

To view the measurement settings:

1. Hold down **[MSR1]** or **[MSR2]** for one second. As an example, take the measurement mode setting in the Basic Measurement screen.
2. Press **[v]** or **[^]** to move to the item that needs to be changed, and then press **[>]** or **[<]** to change the options:

<MSR1>	TGT: Prism
	Const: -30mm
	Mode: Fine[s]
	Rec: All

TGT Prism, reflector sheet, and non-prism.

Const Input prism constant directly (under prism mode). Values: -999~999 mm

Mode Fine[s], Fine [2] ([3]/ [4]/ [5]), Fine[r], Tracking.

Rec Enter, All, Meas.

Enter – A *Rec Pt* screen appears so you can check and confirm before data is recorded.

All – A quick shooting and recording mode. The instrument automatically records the point using the default PtID, and then returns to the Basic Measurement screen.

Meas – The default measuring mode. After a measurement, the instrument stops in the Basic Measurement screen and waits for you to press **[REC/ENT]** before recording the point.

3. After setting, press **[REC/ENT]** to save the setting and return to the last screen.

Display		1/5
HA#	30°21'50"	
VA#	273°13'45"	
SD	m	
PT: 123		
HT	1.000 m	

## **HOT** key

The **HOT** key includes the target height, temperature and pressure, target selection and note input functions. It is available from any observation screen.

To display the *HOT* key menu, press **HOT**.

### Changing the height of the target

1. From the *HOT* key menu, press **1**.

The *Input HT* screen appears.

2. Enter the height of the target, or press the **Stack** softkey to display the HT stack. The HT stack stores the last 20 HT values entered.
3. Press **REC/ENT** to return to the Basic Measurement screen.

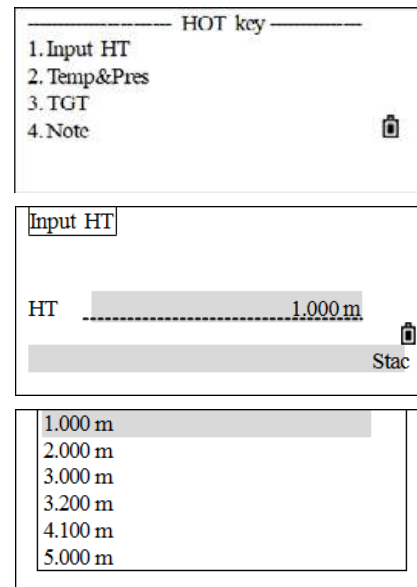

### Setting the temperature and pressure

#### Atmospheric correction

The speed of light in the air is extremely fast. And it is not a constant, but changes with the temperature and pressure of the atmosphere. Once the atmospheric correction is set, the instrument can automatically implement atmospheric corrections.

Even when the instrument is powered off, the atmospheric correction value is still maintained.

The formula for atmospheric correction is: (unit: meter)

$$\text{PPM} = 273.8 - \left( \frac{0.2900 \times \text{pressurevalue(hPa)}}{0.00366 \times \text{temperaturevalue(}^\circ\text{C)}} \right)$$

If the pressure unit is mmHg: 1hPa = 0.75 mmHg

 **Tip** – When disregarding atmospheric correction, set the PPM value to 0. Standard atmospheric condition of the instrument (that is, the atmospheric conditions at which the atmospheric correction value of the instrument is 0):

Pressure: 1013 hPa

Temperature: 20 °C

To set the current temperature and pressure:

1. From the *HOT key* menu, press **2** (or press **v** and **REC/ENT**) to select *Temp&Pres*.

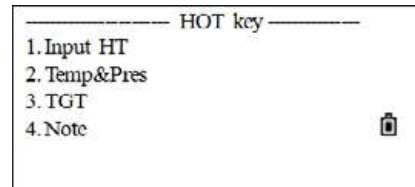

The *Temp&Pres* screen displays the current settings values.

2. Enter the temperature value and press **REC/ENT** to move to next item.
3. Enter the pressure value and press **REC/ENT**.

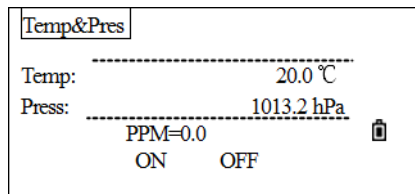

The program calculates the atmospheric correction value, and returns to the normal measurement screen. The atmospheric correction value is calculated according to the input temperature and pressure values.

**Note** – Press *ON* to activate the automatic temperature and pressure sensor, which will detect and fill the temperature and pressure automatically.

Temperature      -40 °C ~ +60 °C (increment 0.1 °C) or -40 °F ~ 140 °F (increment 0.1 °F)

Air pressure      420 ~ 799.5 mm Hg (increment 0.1 mm Hg) or 560 ~ 1066 hPa (increment 0.1 hPa)

16.5 ~ 31.5 inch Hg (increment 0.1 inch Hg)

## Selecting a target set

A target set specifies settings for the target type, the prism constant, and height of target.

When changing the selected target set, all three settings are changed. This function can be used to quickly switch between two types of targets, such as a reflector sheet and a prism.

To select a target set:

1. From the *HOT* key menu, press **3** (or press **v** and **REC/ENT**) to select *TGT*.

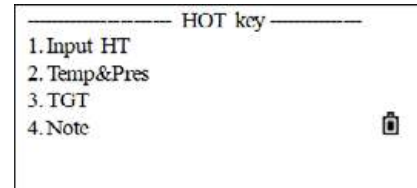

The *TGT* screen appears.

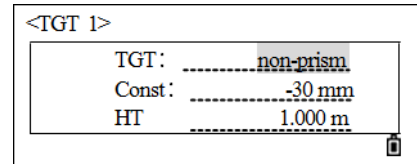

2. Either press the corresponding numeric key (from 1 to 5), or use **v** or **^** to highlight the target set in the list and press **REC/ENT**. To change the settings defined in a target set, highlight the target set in the list and then press the **Edit** softkey.

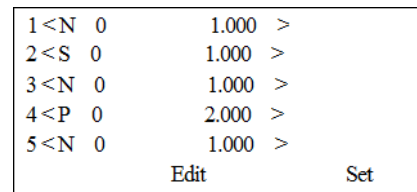

When a target set is selected, the Type and Const values are copied to both **MSR1** and **MSR2** settings. If you have specified a value for HT, this value is also copied to the current HT.

3. After editing, press **REC/ENT**.

The system stores the target set, and returns to the Basic Measurement screen.

Type prism/non prism/reflector sheet  
 Const -999 to 999 mm  
 HT -9.990 to 99.990 m

**Note** – “HT” can be left blank in the target set (input the number beyond the maximum instrument height). If you leave it blank, the current HT value is always applied to the measurement.

## Entering a field note

This function can be used at any time on any observation screen. Each note can be up to 50 characters. The note is stored as a CD record in the raw data.

To enter a field note:

1. From the *HOT key* menu, press **4** (or press **v**) and **REC/ENT** to select *Note*.

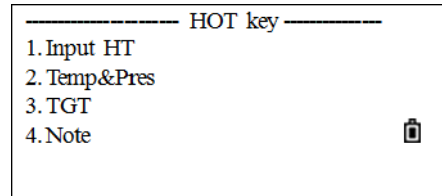

The *Input Note* screen appears.

2. Enter the note and then press **REC/ENT**.

The instrument returns to the Basic Measurement screen.

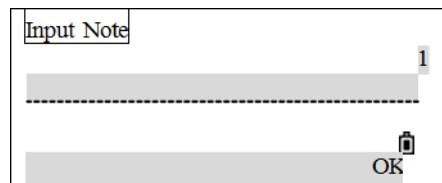

## Starting a survey

After verifying all settings, a survey can be started. The survey results are displayed in four screens including all data for a routine survey. Press **[DSP]** to view the data. If a second distance unit is set, an additional *HD/VD/SD* screen appears.

Before storing measurements, a job, a station, and a backsight azimuth must be set.

1. Sight to the center of target prism, press **[MSR1]** or **[MSR2]**.
2. While the instrument is taking a measurement the prism constant is displayed in the distance field.

Display		1/4
HA#	29°44'21"	
VA#	265°20'53"	
SD#		
PT	1	
HT	1.000 m	

The measurement results are displayed in four screens, including all normal measurement data such as angle, distance, and coordinates.

3. Press **[DSP]** or **[v]** or **[^]** to view each screen.  
If the secondary distance unit is set, another screen appears.

Display		2/4
AZ#	29°44'21"	
HD#	2.274 m	
VD#	-0.185 m	
PT	1	
HT	1.000 m	

To change the height of the target (HT), the temperature, or the pressure, press the **[HOT]** key.

Settings that relate to corrections (T-P, Sea level, C&R) are included in the job settings. These settings are job-specific. Changing any item will create a new job or close the current job.

The maximum data storage capacity is defined by the type of data being stored. The maximum is 10,000 points complete with raw data.



## Angle measurement

1. Press **[ANG]** to open the *Angle* menu.
2. To select a command from this menu, press the corresponding number key or highlight the selection and press **[REC/ENT]**.

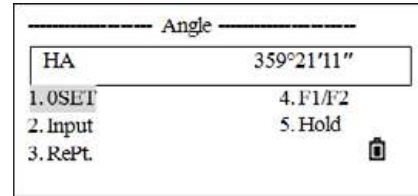

### OSET

Press **[1]** to set HA as 0, and then return to the Basic Measurement screen.

1. From the *Angle* menu, press **[1]** to open the OSET function.
2. The program sets the current horizontal angle to 0, and returns to the Basic Measurement screen.

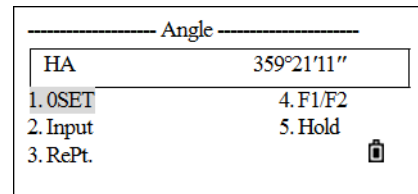

## Enter the horizontal angle

1. From the *Angle* menu, press **[2]** (or press **[v]** and **[REC/ENT]**) to select *Input*.

The *HA Input* screen appears.

2. Enter the horizontal angle value, and then press **[REC/ENT]**.  
For example, to enter 159°46'25", type **159.4625**.

The software returns to the Basic Measurement screen, and displays the entered horizontal angle.

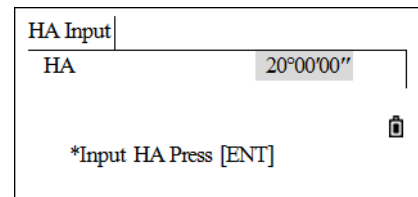

## Repeat angle measurement

This function is used to accumulate repeated angle measurements, displaying the sum and average value of all observed angles. It records the number of observations at the same time.

$$HR\chi = \Sigma HR \div N$$

$$HA = BSA_z + HR\chi(\text{normalized})$$

$HR\chi$  is not updated even if the instrument is moved.

In repeat angle measurement, the HA is replaced by  $\Sigma HR$ , and the number of repeat angles is displayed (for example, N=6).

Horizontal angles can be measured up to 3599°59'59".

This function stores both raw and XYZ data as CP records.

1. From the *Angle* menu, press **[3]** to open the *RePt* screen.  
The system sets the initial value of HR to 0.
2. Sight the first target point that is used in the repeat angle measurement. (i.e. backsight), and press **[REC/ENT]**.
3. Use the horizontal clamp and tangent screw to sight the second target point (i.e. foresight). The horizontal angle is now accumulated.
  - To end the repeat angle measurement, press **[ESC]**.
4. Press **[REC/ENT]** to save the horizontal angles and return to the initial repeat angle measurement screen.
5. Repeat Step 3 through Step 4 as many times as needed.

When enough horizontal angle results have been accumulated, press **[MSR1]** or **[MSR2]** to take a measurement to the foresight. The average horizontal angle is displayed. This value is fixed until the process is finished or cancelled.

1. When enough horizontal angles results have been accumulated, take a measurement to the foresight. First sight the backsight and press **[REC/ENT]**.
2. Sight the foresight, press **[MSR1]** or **[MSR2]** to measure the distance. The measured result is displayed.
3. Press **[REC/ENT]** to record.

## Face-1/Face-2 measurements

Using F1/F2 measurements effectively cancels out mechanical constant error to obtain maximum accuracy for measuring angles.

For the HA to be adjusted from a F1/F2 measurement, the backsight must also have been measured in F1/F2 during the station setup.

To take F1/F2 data without taking a distance measurement:

1. Sight the center of the target prism, and press **[MSR1]/[MSR2]** (this step can be omitted if not taking a distance measurement).

2. From the *Angle* menu, press **[4]** to select *F1/F2*.

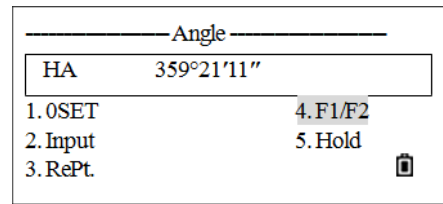

3. The system displays according to the current vertical circle reading. If the vertical circle is on F2, the message Turn to F1 appears. If the vertical circle is on F1, the message Turn to F2 appears.

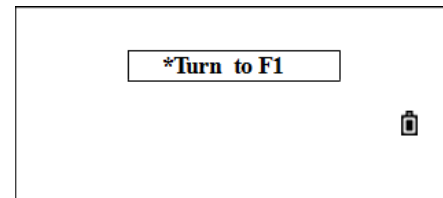

4. Rotate the alidade, and use the horizontal clamp and horizontal tangent screw to sight the same target.

5. Press **[REC/ENT]**, the program will calculate the observation value of F1/F2.

If a distance measurement has already been taken to the target, F1/F2 averaging can be initiated by flipping the telescope to the other face.

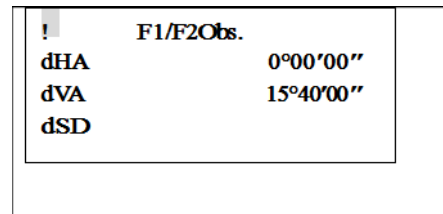

6. If satisfied with the result, press the **OK** softkey, else press the **Abort** softkey. The Basic Measurement screen appears.

## Hold

To hold the horizontal angle to the current value:

1. Press **[ANG]** to open the *Angle* menu.
2. Rotate the horizontal circle to the required horizontal angle, or manually enter the angle value.
3. Press **[5]** (or press **[v]** and **[REC/ENT]**) to select *Hold*.

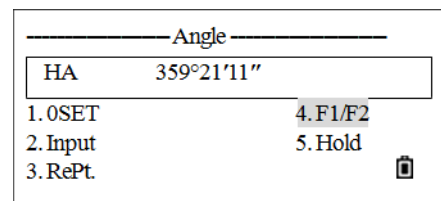

The *HA Hold* screen appears. Use the horizontal clamp and horizontal tangent screw to sight the target.

4. Press **[REC/ENT]** to set the horizontal angle of the target.

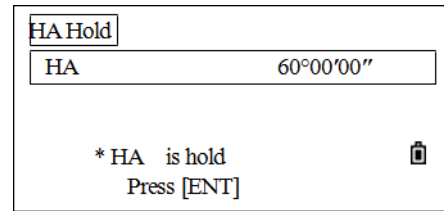

## Quick codes

Quick codes (Qcodes) enable measuring and recording of many points with feature codes in the field.

Using the quick code function, a predefined code can be called up directly via numeric keypad on the instrument. The code is selected by entering a two digit number, by pressing **[MSR1]** the measurement is triggered and the measured data and code saved.

A total of 256 quick codes can be assigned. Each code can be assigned a unique one/two/three digit numbers. If no numbers are allocated to the codes, the code is selected in accordance with the order in which the codes were entered in the code list (for example, 01 = first code in the code list, 10 = tenth code in the code list). For more about editing quick codes, see Adding a code, page 120. You can also use the included Data Transfer software to create and upload codes. See Code list, page 148.

1. To activate Quick code measurement mode, press **[MODE]** in the Basic Measurement screen.
2. Enter the numeric value assigned to the quick code and then press **[REC/ENT]**.
3. The system starts searching the numeric values to find the quick code in its internal memory. To find the quick code corresponding to the numeric value, press **[MSR1]**. After measuring, the result and quick code are displayed. If the quick code corresponding to the numeric value does not exist in internal memory, it will display Code no exist.

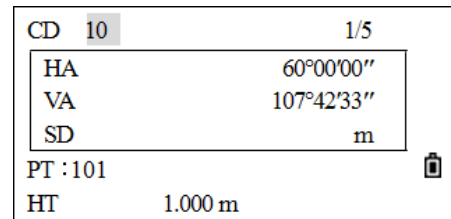

If no quick code is allocated to the numeric value, the Quick Code is numbered in accordance with the order in which the codes were entered in the code list.

4. While measuring, the quick code to be recorded is displayed in the CD field.
5. To quit the quick code function and return to the Basic Measurement screen from the *Qcode* screen, press **[MODE]** again.

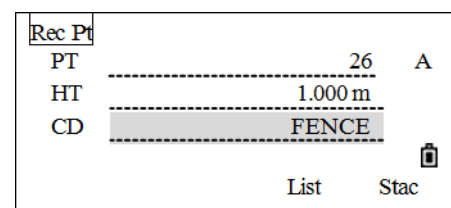

# Applications

**In this chapter:**

- Station key
- Stakeout key
- Measuring offsets
- Program Key
- COD key
- DAT key
- USR 1/USR2 keys

## Station key

To open the *Stn Setup* menu, press **[STN]** in the Basic Measurement screen.

### Setting up a station with known points (coordinates)

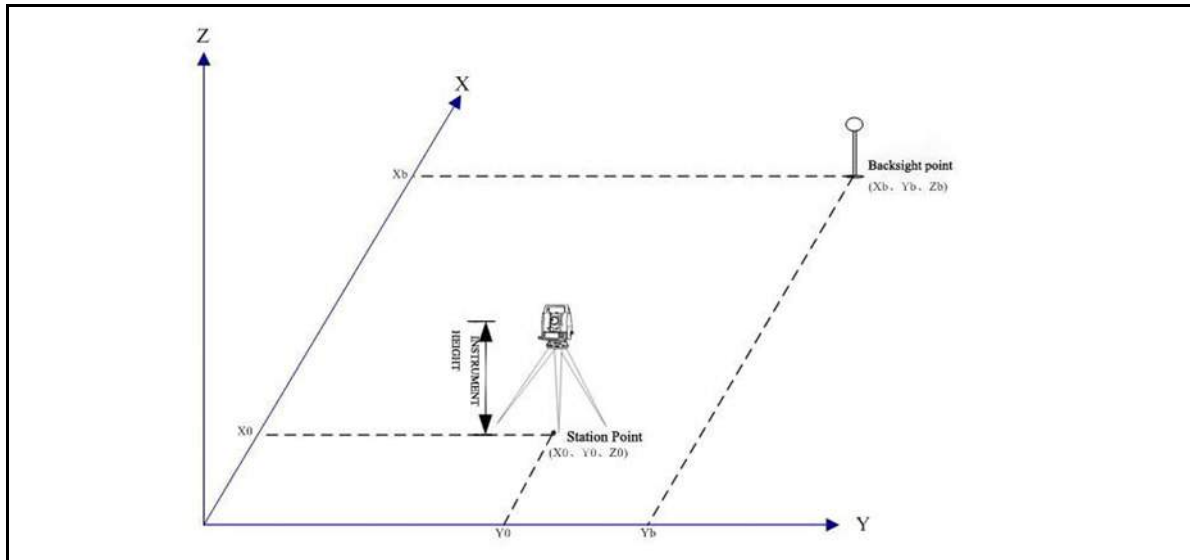

1. From the *Stn Setup* menu, press **[1]** to select *Known*.

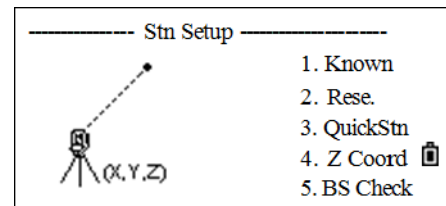

The *Input STN* screen appears.

2. Enter a point name or number in the ST field and press **[REC/ENT]**.
3. Enter the HI (Height of instrument) and press **[REC/ENT]**. To re-enter the known PtID, press **[^]** to move to the ST item and then enter the PtID.
4. Select an input method to define the backsight point:
  - To sight the backsight by entering coordinates, see page 55.
  - To sight the backsight by entering the azimuth or direction, see page 57.

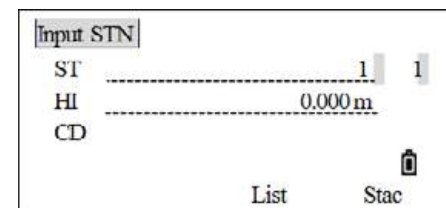

## Sighting the backsight by entering coordinates

To enter coordinates for the backsight point (BS):

1. From the *Backsight* screen, press **[1]** to select *Coord.*
2. Enter the point name and press **[REC/ENT]**.

There are two conditions:

- Measuring to the backsight point. See Measuring the backsight point, page 55.
- Not measuring to the backsight point. See Not measuring the backsight point, page 56.

### Measuring the backsight point

1. If you intend to take a distance measurement to the BS, enter the height of target in the HT field.

2. Sight the BS on Face-1 (F1) and press **[MSR1]** or **[MSR2]** to record a full shot (with HA/VA/SD value).

If the vertical circle is on Face-2, a message Turn to F1 appears. If this happens, rotate the telescope and alidade and sight the BS point in Face-1.

3. After measuring the result is displayed as shown:
  - To determine the backsight point using F1 only, press **[REC/ENT]** to end measuring.
  - To determine the backsight using F2 as well, press the **F2** softkey.
  - To go directly to the Face-2 measurement after taking a distance measurement to the BS on Face-1, flip the telescope. The instrument automatically detects F1/F2.
4. Sight the backsight point, press **[MSR1]** or **[MSR2]** to start the F2 measurement and then press **[REC/ENT]**.

Input BS PT		1
BS	-----	
HT	----- 0.000 m	
CD	-----	
List		Stac

Backsight	
1. XYZ	
2. Angle	
Stac	

Input BS PT		1
BS	----- 3	
HT	----- 1.500 m	
CD	-----	
Stac		

Stn Setup		1/2
AZ	30°21'50"	
HD	m	
SD	m	
* Obs.BS [MSR]/[ENT]		F2

Stn Setup		1/2
AZ	30°21'50"	
HD#	2.178 m	
SD#	2.186 m	
* Press [ENT] End		F2

Stn Setup		1/2
AZ	30°21'50"	
* Turn to F2		
* Press [ENT] End		F2

- If you are measuring to a known coordinate BS, press **[DSP]** to display a QA (quality assessment) screen. To record a CP record that stores the averaged HA, VD, and SD from the F1/F2 data, press the **[CP]** softkey. To record only the ST and F1/F2 records, without a CP record press the **[OK]** softkey. Press the **[ABRT]** softkey to cancel the procedure.

This operation records the station and raw data to the current job and finishes setting up the station. The screen returns to the Basic Measurement screen.

**Note** – AZ = Azimuth calculated by coordinates.

**Note** – Press **[V]** or **[DSP]** to switch to the QA screen (dHD and dVD values), which indicate the difference between the measured distance and the distance calculated from the known coordinates.

**Note** – The instrument automatically detects F1/F2.

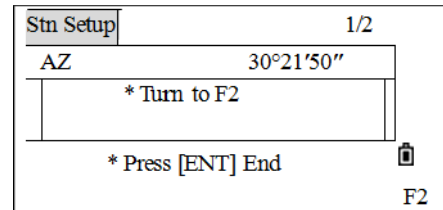
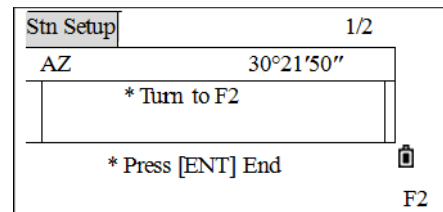

### Not measuring the backsight point

- If not measuring the backsight point, press **[REC/ENT]**.

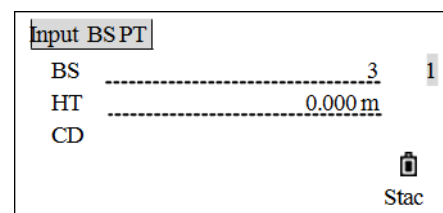

- Sight the BS point in F1, and press **[REC/ENT]** to finish the setting.

If the vertical circle is on Face-2, a message Turn to F1 appears. If this happens, rotate the telescope and alidade and sight the BS point in Face-1.

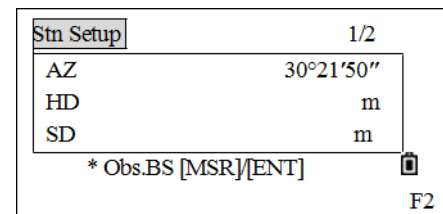

This records the station and raw data to the current job and finishes setting up the station. The screen returns to the Basic Measurement screen. AZ item displays the result of determining the backsight azimuth.



## Sighting the backsight by entering the azimuth angle

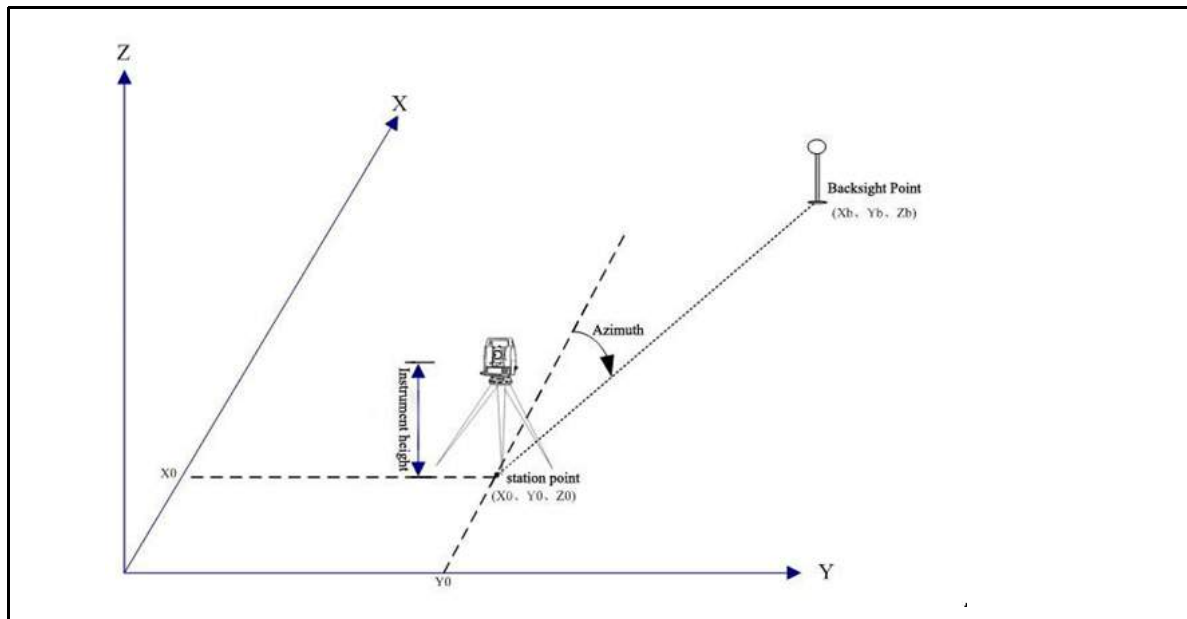

To enter the azimuth angle to the backsight point:

1. From the *Backsight* screen, press **[2]** (or press **[v]** and **[REC/ENT]**) to select *Angle*.

Backsight	
1. XYZ	
2. Angle	<b>[i]</b>

The *Input BS PT* screen appears.

2. Enter a point name and press **[REC/ENT]**.

**Note** – The backsight point here cannot be a known PtID in the internal memory. Otherwise the program will display the coordinate of this point and enter into the function of sighting the backsight by entering coordinates.

Input BS PT	
BS	_____ 1
HT	_____ 0.000 m
CD	_____ <b>[i]</b>
List    Stac	

3. If only the azimuth needs to be entered, when the cursor is in the BS field press **[REC/ENT]**.
4. Enter the azimuth angle to the BS point.

If **[REC/ENT]** is pressed without entering a value in the AZ field, the azimuth is automatically set to 0°00'00".

5. Sight the BS point on F1 and press **[REC/ENT]**.
6. Enter the target height of the BS point and press **[REC/ENT]**.
7. Once again, there are two ways to determine the backsight:
  - Do not measure, press **[REC/ENT]** directly.
  - Measuring using the **[MSR1]** and **[MSR2]** keys. Refer to the previous procedure.

8. If the vertical circle is on Face-2, a message Turn to F1 appears. If this happens, rotate the telescope and alidade and sight the BS point in Face-1.

The station and raw data are stored in the current job and the station setup is completed. The screen returns to the Basic Measurement screen. The AZ item displays the result of determining the backsight azimuth.

Display	1/5
AZ#	0°00'00"
HD#	
SD#	
PT	1 
HT	1.000 m

## Multiple point resection

A resection sets up the station using angle/distance measurements to known points.

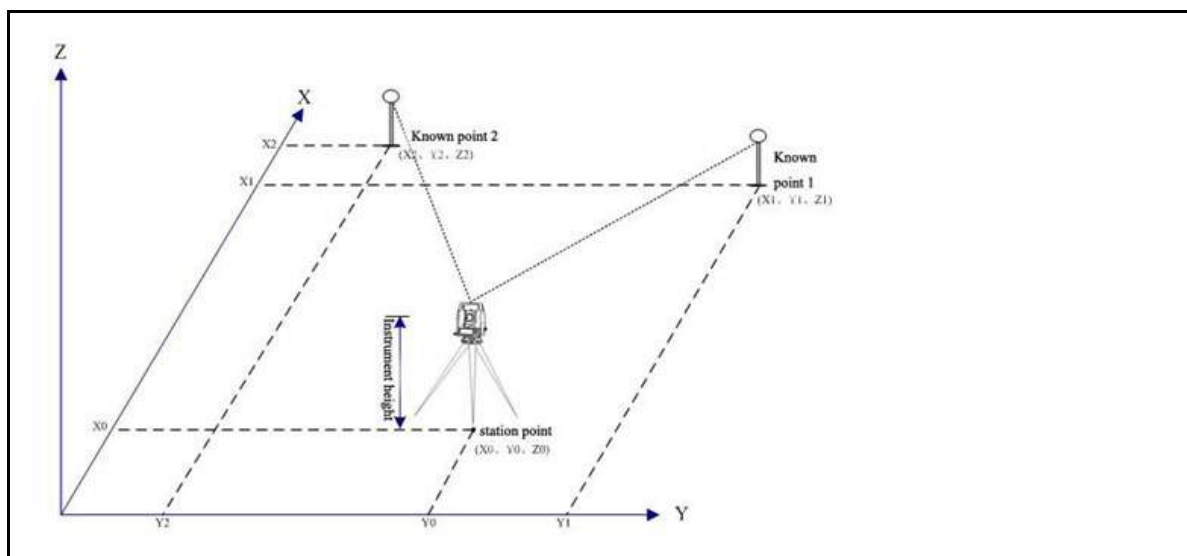

- A maximum of 10 points can be used in a resection.
- Measurements can be distance and angle, or angle only.
- Calculation starts automatically when enough measurements are taken.
- Poor observations can be deleted and recalculated if necessary.
- The minimum data required for a resection is either three angle measurements, or two distance measurements.

**Note** – If the angle between known point 1 and known point 2 (measured from the station point) is extremely acute or extremely obtuse, the resulting solution will be less reliable geometrically. For geometric reliability, select known point locations (or station point locations) that are widely spaced.

To start the resection:

1. From the *Stn Setup* menu, press **[2]** (or press **[v]** and **[REC/ENT]**) to select *Rese* (Resection).

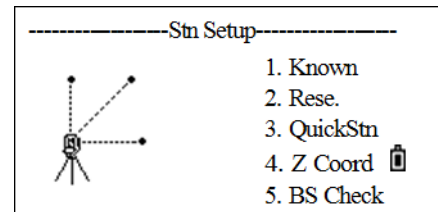

The *Input PT01* screen appears.

2. Enter the point name for the first observation point (that is PT01) and then press **[REC/ENT]**.
3. Enter the target height and press **[REC/ENT]**.
4. Sight the center of the first target prism on F1 and press **[MSR1]** or **[MSR2]** to start the survey. If only the angle needs to be measured, press **[REC/ENT]**.

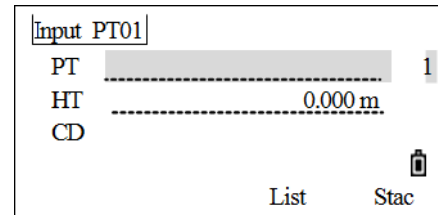

If the vertical circle is on Face-2, a message Turn to F1 appears. If this happens, rotate the telescope and alidade and sight the BS point in Face-1.

5. The measurement result appears. Press **[REC/ENT]**. To measure the backsight point on F2, press the **F2** softkey. Rotate the telescope and alidade, sight the center of the first target prism on F2 and press **[MSR1]** or **[MSR2]** and then press **[REC/ENT]**.
6. If you have measured on both F1 and F2, a QA screen appears. Press **[REC/ENT]** or the **[OK]** softkey to record the result.
7. Enter the second point (PT02) and its height of target and then press **[REC/ENT]**.
8. Repeat this procedure to measure target point 02 and other target points.
9. When the instrument has enough data, it calculates the station (STN) coordinates.
  - If more than 2 points are available, a standard deviation screen appears.

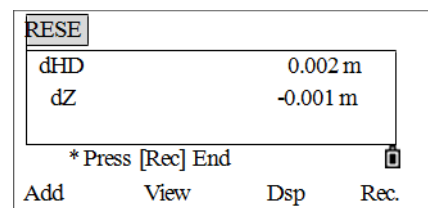
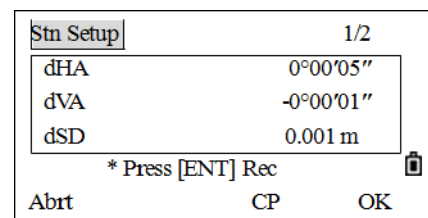
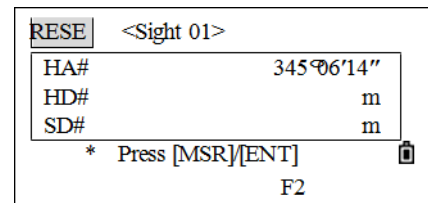

10. To take measurements to strengthen the geometry of the resection, press the **Add** softkey.

RESE	
dN	0.005 m
dE	0.003 m
dZ	-0.001 m
* Press [Rec] End	
Add	View Dsp Rec.

To check the measurements to each known point press the **View** softkey. Press **↓** or **↑** to select the point on the screen and then press **[REC/ENT]** to check the measurements to each known point. At this point poor observations can be deleted or observation points added.

dHA Distributed HA errors in each direction  
 dVD VD errors between measured distance and calculated distance  
 dHD HD errors between measured distance and calculated distance

11. When the results are satisfactory, record the station. To do this, press **[REC/ENT]** or the **Rec.** softkey. The ST column defaults to the last recorded PT + 1.
12. BS defaults to the first observed point. To change the BS, press the **Var** softkey.
- Press **↓** or **↑** to select the BS point that you want to use and then press **[REC/ENT]**.

Input STN	
ST	10 1
HI	1.800 m
CD	
BS	1
List Stac	

13. The *Input STN* menu screen appears. Press **[REC/ENT]** to record the station and backsight. The *Stn Setup* screen appears.

**Tip** – To delete a measurement, highlight the measurement data or display the detail screen for the measurement. Then press the **DEL** softkey. The STN coordinates are automatically recalculated.

Basically, Stn-Z is calculated from distance-measured data. If no distances are measured, then Stn-Z is calculated using angle-only measurements to known points with 3D coordinates.

## Quick station

Use this option to set up a station quickly without coordinates.

The station point (ST) in this function defaults to a new point number. For the new point, MP (0, 0, 0) is stored as the coordinates. When the ST is manually changed to a known point name, the station is set up on the coordinates of the known point.

Even if both ST and BS are known points, this function does not calculate the backsight angle (AZ) automatically. To calculate the AZ between two known points (ST and BS), select *Station Setup / Known*.

1. From the *Stn Setup* menu, press **3** (or press **v** and **REC/ENT**) to select *QuickStn*.

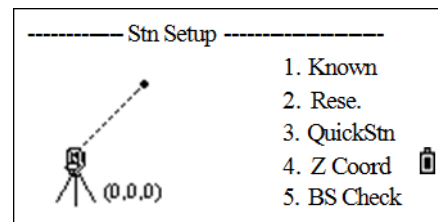

The *QuickStn* screen appears.

2. Enter the ST point name and then press **REC/ENT**. The station point defaults to the last recorded PT + 1, or ST + 1, depending on the Split ST setting.

3. Enter the height of the instrument and then press **REC/ENT**.
4. No default PT is assigned to the BS. Leave this field blank, or enter a BS point name.
5. The backsight azimuth (AZ) defaults to zero, but this can be changed.
6. To complete the station setup, sight the BS and press **REC/ENT**.

When you press **REC/ENT** in the AZ field, both HA and AZ are reset to the value you have entered.

**Note** – For the Split ST setting, see *Settings*, page 110.

## Height transfer (determining station elevation)

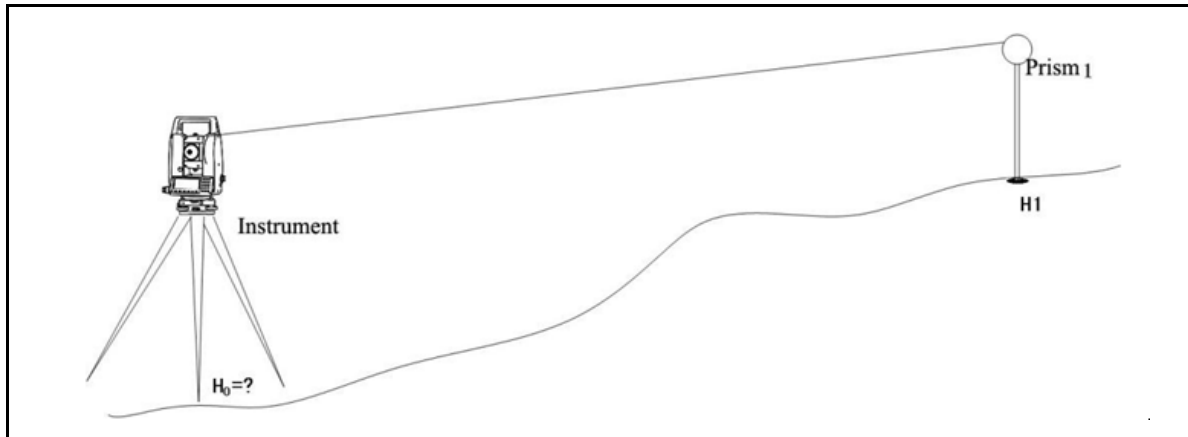

This function determines the height of the instrument from measurements to target points with known heights, in two faces.

After measurement, the new height of the station appears.

To enter the height transfer function:

1. From the *Stn Setup* menu, press **4** (or press **v** and **REC/ENT**) to select *Z Coord*.

If no station was previously set up, the message *Invalid STN* appears. Press any key to return to the *Stn Setup* menu and select any method to set up a station.

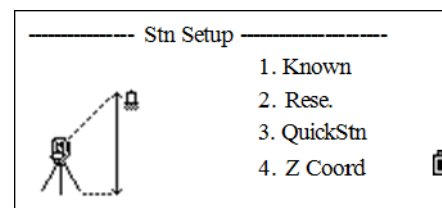

2. Once the program records the station, enter a point with known elevation and then press **REC/ENT**.
3. Enter the height of the target prism and then press **REC/ENT**.

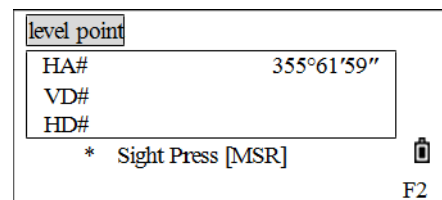

4. Sight the center of the prism and then press **MSR1** or **MSR2** to measure.

If the vertical circle is on Face-2, a message *Turn to F1* appears. If this happens, rotate the telescope and alidade and sight the BS point in Face-1.

The total station finishes the measurement and displays the result.

5. **Optional.** Press the **F2** softkey and rotate the telescope and alidade and sight the center of the prism in Face-2, and then press **MSR1** or **MSR2** to measure.
6. Once the measurements on F1 and F2 are finished, press **REC/ENT**.
7. The result screen appears, press the **OK** softkey to confirm, or **Back** to remeasure.
8. The updated station coordinates are displayed and the height, Z, is updated. The HI can also be changed in this screen. When HI is changed, the Z coordinate is updated before the station is recorded.
9. Press **REC/ENT** to record the updated STN. The *Stn Setup* menu screen appears.

## Checking and resetting the backsight direction

**Note** – A station setup must be completed before the BS check function is used.

1. From the *Stn Setup* menu, press **5** (or press **v** and **REC/ENT**) to select *BS Check*.

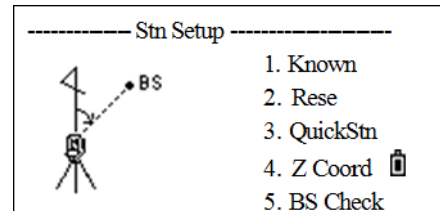

The *BS Check* screen appears.

2. Sight the BS point and press the **Redo** softkey or **REC/ENT** to reset the horizontal angle to the HA set in the last station setup.

HA      Current HA reading

BS      The HA to the BS in the last station setup

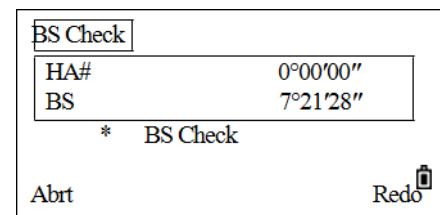

3. To cancel the process and return to the Basic Measurement screen, press the **Abt** softkey or **ESC**.

The screen returns to the Basic Measurement screen and HA is set.

## Stakeout key

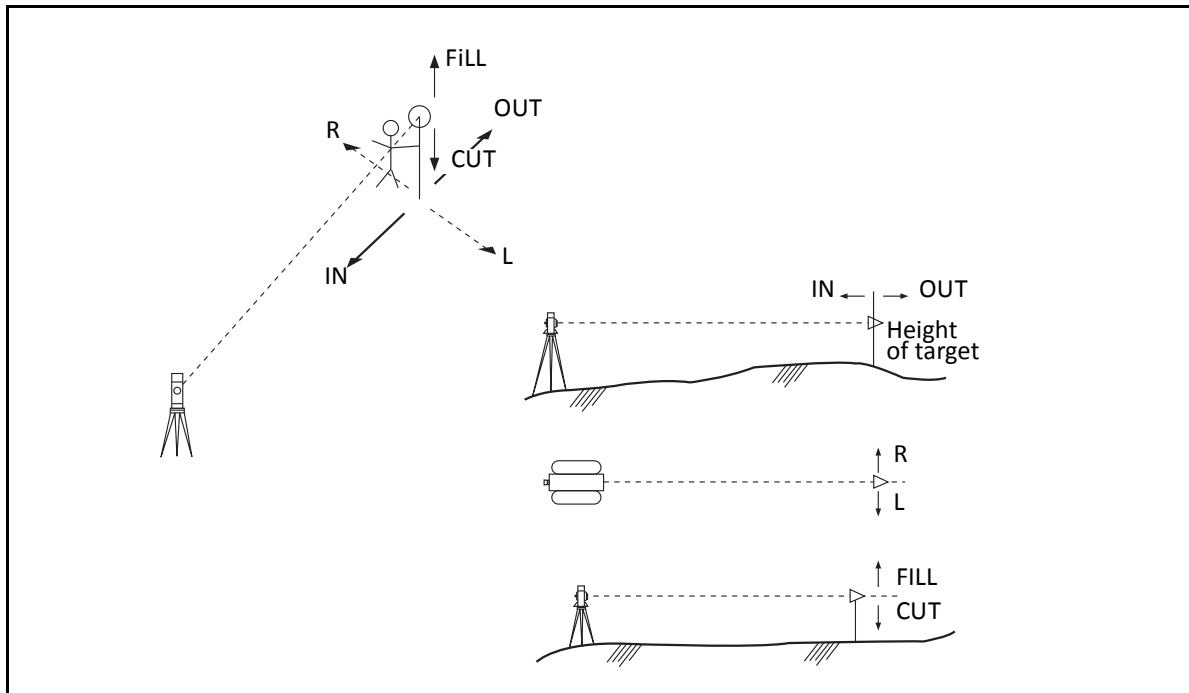

To display the *Stakeout* menu, press **[S-O]**.

## Stakeout by angle and distance

1. Press **[8]** to enter the stake-out function. A station setup and backsight azimuth must be set before stakeout. If this is not done, a Station not set message is displayed.
2. Press **[1]** to continue. This displays the ST, HI, and BS set in the last operation. Press the **OK** softkey to confirm or press the **Abt** softkey to quit the program.

STN Check	
ST	1 1
HI	1.800 m
BS	2
Abt OK	

After the program records the STN data, the screen returns to the *SO* menu.

3. Press **[1]** or select **HA-HD** to display the input screen for the distance and angle to the target.
4. Enter the values and press **[REC/ENT]**.

HD Horizontal distance from station point to stakeout point  
 dVD Vertical distance from station point to stakeout point  
 HA Horizontal angle to stakeout point

SO	
	<ol style="list-style-type: none"> <li>1. HA-HD</li> <li>2. XYZ</li> <li>3. PartLine</li> <li>4. Ref. Line</li> </ol>
Abt OK	



- To start staking out, rotate the instrument until the dHA displays 0°00'00".
- Sight the target and press **[MSR1]** or **[MSR2]** to measure the distance.

When the measurement is completed, the differences between the target position and the stakeout point are displayed.

dHA	Difference in horizontal angle to the target point
R/L	Right/Left (Lateral error)
IN/OUT	In/Out (Longitudinal error)
CUT/FILL	Cut/Fill

**Note** – If you press **[REC/ENT]** without entering HA, the current HA is used.

**Note** – Once a measurement is taken, the Cut/Fill value and Z coordinate are updated as the VA is changed.

- Move the prism forward or backward according to the arrowhead until the IN/OUT field displays 0,0.

An up arrow signifies to move away from the station (OUT).

A down arrow signifies to move toward the station (IN).

When both R/L and IN/OUT display 0 m, it indicates the prism is on the stakeout point.

The fifth line shows the Cut or Fill data.

- After staking out, press **[REC/ENT]** to record the stakeout point. PT defaults to the last recorded PT+1, input code (CD) if necessary. Press **[REC/ENT]** to record the point.

After recording the point, it returns to the observation screen. The current observation can be continued, or press **[ESC]** to enter another angle and distance for stakeout.

**Note** – If **[REC/ENT]** is pressed without entering HA, the current HA is used.

All observation results display in 8 screens, press **[V]** or **[DSP]** to switch between display screens:

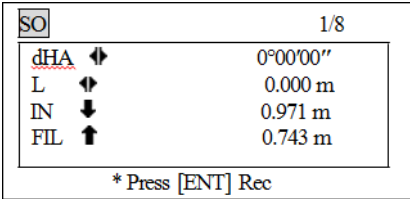
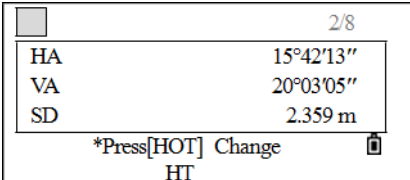
Display	Description
	This screen displays stake-out.
	<p>This screen displays the slope distance measurement of target prism. Press <b>[HOT]</b> to open the <i>HOT</i> Key menu.</p> <p><b>Note</b> – If <b>[HOT]</b> is pressed in any observation screen, the <i>HOT</i> key menu appears. This menu can be used at any time to change HT and T-P.</p>

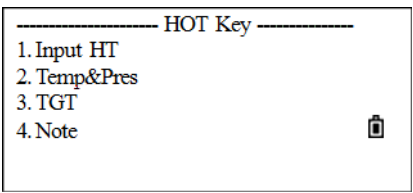
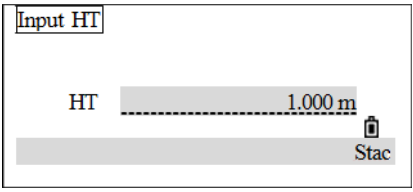
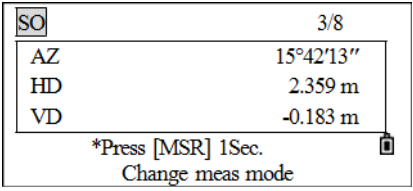
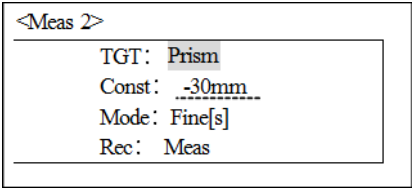
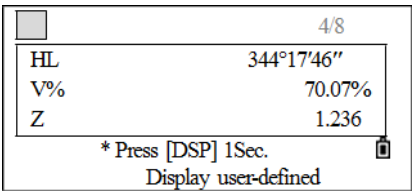
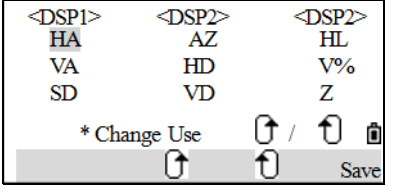
Display	Description
	<p>When the cursor is on Input HT, press <b>[REC/ENT]</b> to open the Input HT function.</p>
	<p>After entering the height of the target, press <b>[REC/ENT]</b> to return to screen 2/8 of the SO.</p>
	<p>This screen displays the horizontal distance measurement of target prism. Press <b>[MSR1]</b> or <b>[MSR2]</b> for 1 second to change the measure mode.</p> <p>Press <b>[^]</b> or <b>[v]</b> to move to the item to change, press <b>[&gt;]</b> or <b>[&lt;]</b> to change.</p> <ul style="list-style-type: none"> <li>• TGT: Prism, non-prism, reflector sheet</li> <li>• Const: Enter the prism constant directly (In prism mode)</li> <li>• Mode: Fine[s] / Fine[2](3/4/5) /Fine[r]</li> <li>• Tracking</li> <li>• Rec: Meas, Enter, All</li> </ul>
	
	<p>The data listed on the display screen can be changed. Press <b>[&gt;]</b> / <b>[&lt;]</b> or <b>[^]</b> / <b>[v]</b> to select.</p> <p>Use the <b>[F1]</b> or <b>[F2]</b> softkey to change.</p> <p>Press <b>[REC/ENT]</b> or press the <b>SAVE</b> softkey to make the changes valid.</p>
	

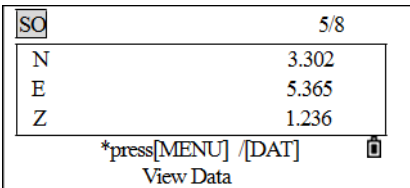
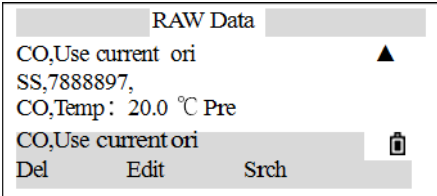
Display	Description
	<p>The screen stays on the measured results. Press <b>[REC/ENT]</b> to display detailed information.</p> <p>For a detailed description of the data, see Data, page 112.</p>
	
Screen 6/8	This screen displays coordinate deviation values, press <b>[REC/ENT]</b> to record data.
Screen 7/8	Press <b>[HOT]</b> to change the height of target. See screen 2/8.
Screen 8/8	If the secondary distance unit is set, the screen 8/8 appears. For setting a secondary unit, see Settings, page 110.

## Coordinates stakeout

To start a stakeout by coordinates:

- From the *Stakeout* menu, press **[2]** (or press **[v]** and **[REC/ENT]**) to select XYZ.
- Do one of the following:
  - Enter the name of the point to be staked and press **[REC/ENT]**. After finding the point name, the program proceeds to Step 4. To display the coordinates, press **[REC/ENT]** to confirm.
  - Specify a stakeout list by range input. To enter points by range, press the **Fr/To** softkey in the PT field, as shown. Enter the start point (Fr) and the end point (To). The last digit of the point name must be a number. If existing points are found between Fr and To, a point list is displayed.

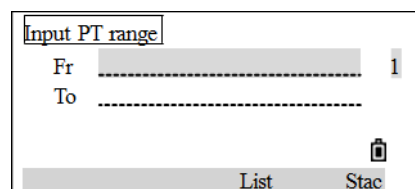
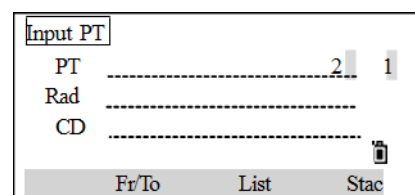
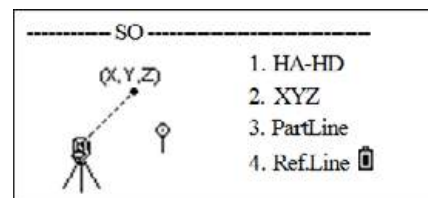

- Specify the point by code and/or radius from the instrument.

- If several points are found, they are displayed in a list. Use  $\uparrow$  or  $\downarrow$  to move up and down the list. Use  $\leftarrow$  or  $\rightarrow$  to move up or down one page. Highlight a point in the list and press  $\text{REC/ENT}$ .
- The screen displays the coordinate of the selected point name. To confirm, press  $\text{REC/ENT}$ .

The delta angle and the distance to the target (HD) are shown.

- Rotate the instrument until the dAZ is  $0^{\circ}00'00''$ . Press  $\text{MSR1}$  or  $\text{MSR2}$ .

dHA          Difference in horizontal angle to the target point.

HD            Horizontal distance to the target point.

- After measuring, the deviation value between measured point and stakeout point is shown:

dHA          Difference in horizontal angle to the target point

R/L          Right/Left (Lateral error)

IN/OUT      In/Out (Longitudinal error)

CUT/FILL    Cut/Fill

- Move the rodman to the target position. When the target is on the intended position, the displayed errors become 0.000 m (or 0.000 ft).

An up arrow signifies to move away from the station (OUT).

A down arrow signifies to move towards the station (IN).

When both R/L and IN/OUT display 0 m, it indicates the prism is on the stakeout point.

The fifth line shows the Cut / Fill data.

**Note** – Once a measurement is taken, the Cut/Fill value and Z coordinate are updated as the VA is changed.

- To record the stakeout point, press  $\text{REC/ENT}$ . PT defaults to the last recorded PT + 1.

- If required, a code (CD) can be entered.

After recording the point, the display returns to the observation screen. When  $\text{ESC}$  is pressed, the display returns to the PT/CD/R input screen. If the stakeout point is entered using a single point name, the PT defaults to the last PT + 1.

If a point is selected from the list, the display returns to the list, unless all points have been selected. Press  $\text{ESC}$  to return to the point input screen.

**Note** – If a control job is assigned, and additional points are found in the control job, the  $\text{Ctrl}$  softkey appears below the list.

**Note** – Use the Add Constant field in MENU > 3 Settings > 6 SO to specify an integer that is added to the point number being staked to generate a new number for recording the staked point. The default value is 1000. For example, when PT3 is staked out with an Add Constant of 1000, the default number for SO record is PT1003. For more information, see Stakeout key, page 64.

All observation results appear in eight screens: Press  $\square$  or press the DSP softkey to switch between display screens. For more information, see Stakeout by angle and distance, page 64.

## Partline stakeout

This function divides the line between the instrument and the target by an input span number. It then guides the stake out of the points, one by one.

For example, if a measurement is taken to the end point at 100 m from the instrument and the span total is set to 2, the following four points are calculated and can be staked:

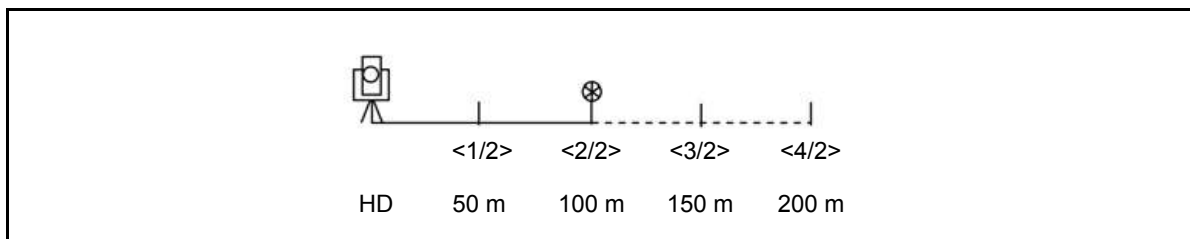

1. From the SO menu, press  $\text{3}$  (or press  $\square$  and  $\text{REC/ENT}$ ) to select *PartLine*.

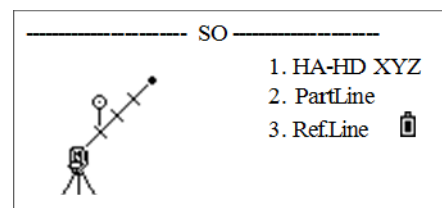

The *PartLine* screen appears.

2. Set up the baseline. To do this, sight the target and press  $\text{MSR1}$  or  $\text{MSR2}$ . The system sets up a base line between the instrument and the measured point.

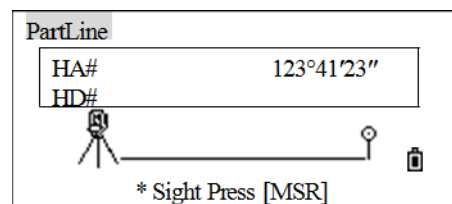

3. Enter the total stake number in the Partition field and press  $\text{REC/ENT}$ .

The observation screen for the first stakeout point (from the instrument) appears. Sight the prism and press  $\text{MSR1}$  or  $\text{MSR2}$ .

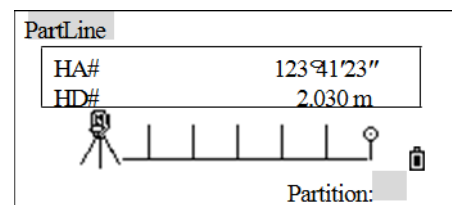

When the measurement is completed, the differences between the target position and the stakeout point are displayed.

HA	Difference in horizontal angle to the target point
R/L	Right/Left (Lateral error)
IN/OUT	In/Out (Longitudinal error)

4. Move the rodperson to the target position. When the target is on the intended position, the displayed errors become 0 m (or 0 ft).  
An up arrow signifies to move away from the station (OUT).  
A down arrow signifies to move towards the station (IN).
5. If the third line L/R does not display 0 m, move the rodman to the target position.  
An arrow pointing to the right shows that the rodman moves to their left side.  
An arrow pointing to the left shows that the rodman moves to their right side.  
When both R/L and IN/OUT display 0 m, it indicates the prism is on the stakeout point.
6. After staking out, press **[REC/ENT]** to record the stakeout point. PT defaults to the last recorded PT+1, and a CD (code) may also be entered if required.
7. After recording the point, the display returns to the SO screen. Press the **Prev / Next** softkeys or use **[^]** or **[v]** to stakeout other divided points.

## RefLine stakeout

This function allows a point to be staked based on the Sta, O/S, and dZ to a specified line.

1. From the *SO* menu, press **[4]** (or press **[v]** and **[REC/ENT]**) to select *RefLine*.

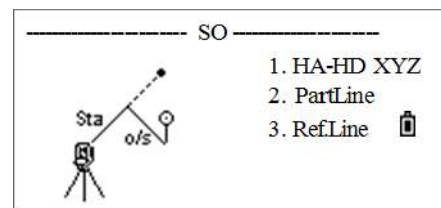

The *Input P1* screen appears.

2. Enter the first point (P1) of the line and press **[REC/ENT]**.

**Note** – If **[REC/ENT]** is pressed without entering a PT name, temporary coordinates can be entered which are not recorded in the job. Alternatively, press the **MSR** softkey to measure a point.

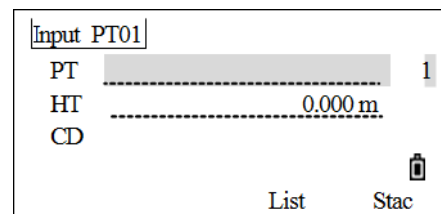

3. Enter the second point (P2) of the line.
4. Enter offsets to the line. Press **[REC/ENT]** in a blank field to enter the value 0.0000.

Sta      Distance from P1 along the line  
 O/S     Offset to the reline  
 (+)     Right side of the P1-P2 line  
 (-)     Left side of the P1-P2 line  
 dZ      dVD to line

- Start the stakeout. Rotate the instrument until the dAZ is 0°00'00".
- Sight the target and press **[MSR1]** or **[MSR2]**.

dAZ           Azimuth error to target point  
 HD           Horizontal distance to the target point

- After measuring, the deviation value between measured point and stakeout point is shown.

dHA           Difference in horizontal angle to the target point  
 R/L           Right/Left (Lateral error)  
 IN/OUT       In/Out (Longitudinal error)  
 CUT/FILL     Cut/Fill

Ref.Line	<1/8>
dAZ ←	23°41'23"
HD#	17.071 m
* Sight Press [MSR]	
OK	

PT	1/8
dHA ↕	0°00'00"
STP ↕	0.000 m
IN ↓	3.971 m
FIL ↑	0.743 m
* Press [ENT] Rec	

- Move the rodman to the target position. When the target is on the intended position, the displayed errors become 0.000 m (or 0.000 ft).  
 An up arrow signifies to move away from the station (OUT).  
 A down arrow signifies to move towards the station (IN).  
 When both R/L and IN/OUT display 0 m, it indicates the prism is on the stakeout point.  
 The fifth line shows the Cut/Fill data.
- After staking out, press **[REC/ENT]** to record the stakeout point. PT default to the last recorded PT+1, and a CD (code) can be entered if required.
- After recording, the point, the display returns to the SO screen. Press **[ESC]** to re-enter the offsets. Repeat Step 4 through Step 9 to carry out a Ref.Line stakeout.

All observation results appear in 8 screens: Press **[v]** or the **DSP** softkey to switch between display screens. For more information, see Stakeout by angle and distance, page 64.

**Note** – To input PtID, see *Entering a point name or number*, page 38.

# Measuring offsets

## Measuring distance offsets

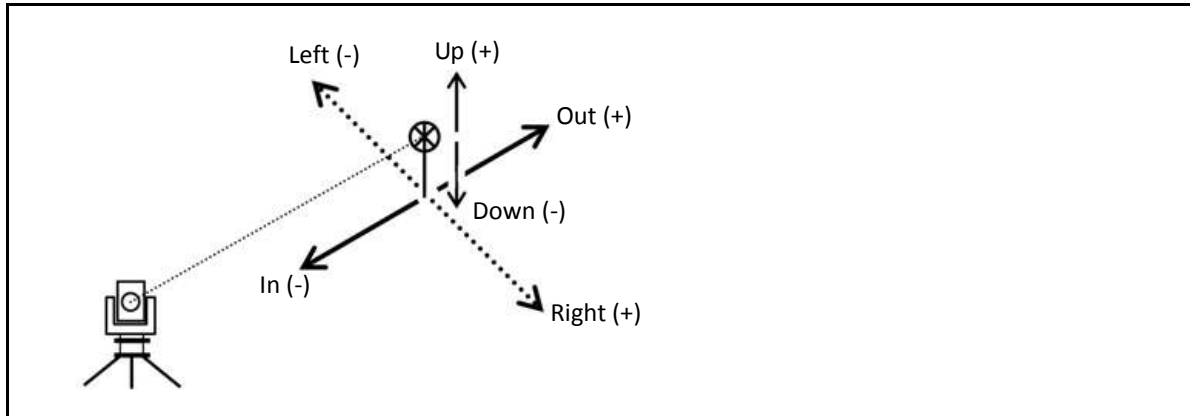

1. To enter the offset function, press **[9]**. A station setup and backsight azimuth must be set before stakeout. If this is not done, a Station not set message is displayed.

2. Press **[1]** to continue. This displays the ST, HI, and BS set in the last operation. Press the **OK** softkey to confirm or press the **Abt** softkey to quit the program.

Press the **STN** softkey to enter the *Stn Setup* menu and select one method to set the station. Press the **OK** softkey to confirm or press the **Abt** softkey to quit the program.

After the program records the STN data, the screen returns to the *Offset* menu.

3. To enter the distance offset function, press **[1]** or select **O/S Dist** in the *Offset* menu.

If a distance measurement has not been taken before entering this function, a temporary measurement screen appears.

4. Sight the target and press **[MSR1]** or **[MSR2]**.

5. Enter a combination of distance offsets to specify the point. Press **[REC/ENT]** to move to the next field.

The calculated coordinates are shown.

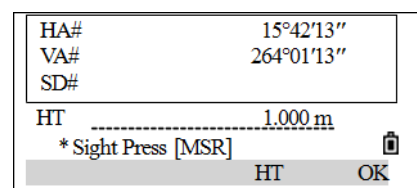
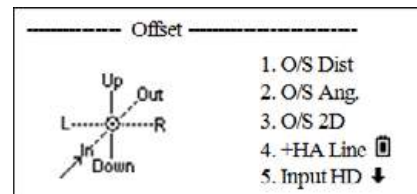
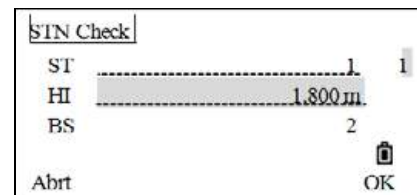



6. Enter a PT (and CD) value.
7. Press **[REC/ENT]** to record the point and return to the Basic Measurement screen.

Raw data is also recalculated, based on the taped offset value.

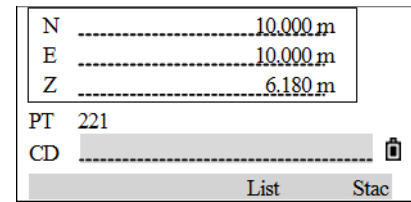

## Measuring angle offsets

1. From the *Offset* menu, press **[2]** (or press **[v]** and **[REC/ENT]**) to select *O/S Ang.*

If a distance measurement has not been taken before entering this function, a temporary measurement screen appears.

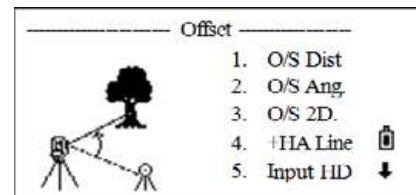

2. Sight the target and press **[MSR1]** or **[MSR2]**. The measurement results are shown. Press the **[DSP]** softkey or **[v]** to view each result screen.

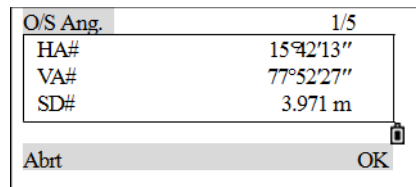

3. To take the angle offset, rotate the alidade and telescope. The measured distance (HD) remains unchanged.
4. To record the offset point, press **[REC/ENT]** or the **[OK]** softkey; alternatively, press the **[ABRT]** softkey.

The XYZ data is also recalculated, based on the new angle.  
The display returns to the Basic Measurement screen.

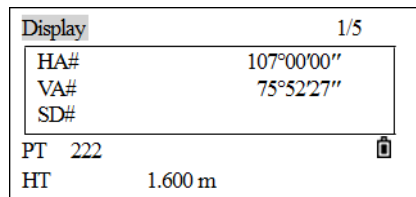

An angle offset can also be recorded in the Basic Measurement screen.

1. If a distance measurement has not been taken before entering this function, a temporary measurement screen appears. Sight the target and press **[MSR1]** or **[MSR2]**.
2. After taking a distance measurement, rotate the alidade and/or telescope. Press the **[DSP]** softkey or **[v]** to view other pages in the result.
3. Press **[REC/ENT]** to record the measured distance with the updated angle value.

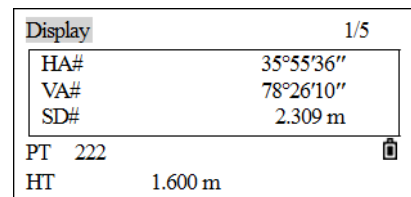

## Two-prism pole

- From the *Offset* menu, press **3** (or press **v** and **REC/ENT**) to select *O/S 2D*.
- Sight the first prism and press **MSR1** or **MSR2**.  
The program enters the second point screen automatically. Sight the second prism and then press **MSR1** or **MSR2**.
- Enter the distance between the second prism and the target point. Alternatively, if QA information is not needed, leave the distance between the first and the second prism blank.
- If a P1-P2 distance is entered, the *QA* screen appears. Compare the entered value and the measured distance to check the accuracy of the observation. To re-enter the distances, press the **Redo** softkey. To confirm, press the **OK** softkey or **REC/ENT**.
- To record the point, press **REC/ENT** or the **OK** softkey.

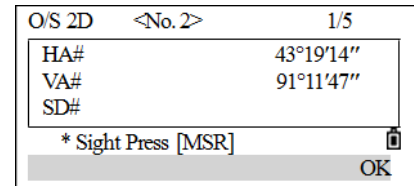
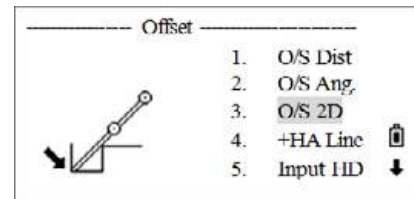

### Sample records

CO,2Prism O/S: P1-P2= 0.5000 (5.005) P2-Tgt= 2.000

## +HA line

This function is used to extend a line by the horizontal angle offset.

- From the *Offset* menu, press **4** (or press **v** and **REC/ENT**) to select *+HA Line*.

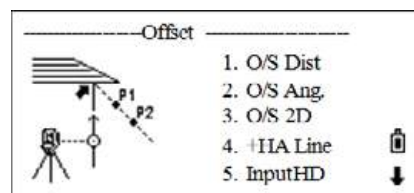

The *+HA Line* screen appears.

- Sight the first prism (or target) and press **MSR1** or **MSR2**.  
The display moves automatically to the next screen.

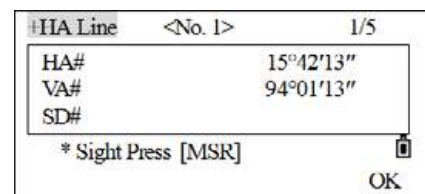
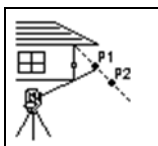

- Sight the second prism (or target) and press **[MSR1]** or **[MSR2]**.

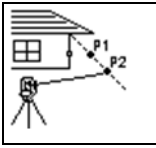

- Sight the alternative place on the same vertical line as the required target point.

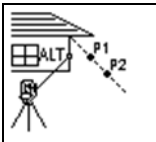

- To calculate the coordinates and the raw data of the target point, press **[REC/ENT]** or the **OK** softkey.
- To record the point, enter a PT (and CD) value and press **[REC/ENT]**. The height of target is fixed to 0.0000 for the offset point.

**Note** – The calculated point (TGT) is stored as an SS record.

**Note** – Measurements to the first and second target (P1 and P2) are stored as comment records (PT1 and PT2). The last record records the angle measurement to the ALT (vertically offset point from the actual target point).

## Input HD

This function is useful when the instrument is very close to the point and it is difficult to take a measurement using the EDM.

- From the *Offset* menu, press **[5]** (or press **[v]** and **[REC/ENT]**) to select *Input HD*.

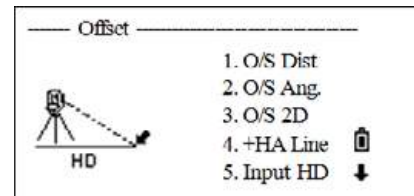

The *Input HD* screen appears.

- Turn the telescope in the direction of the point to be stored.
- Enter the HD and press **[REC/ENT]**.

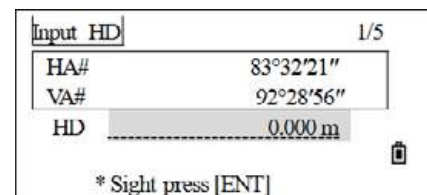
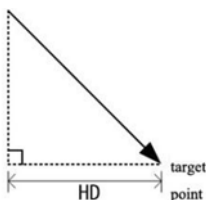

- Enter a PT (and CD) value and press **[REC/ENT]**.

The target point is calculated and recorded as an SS record.

## Calculating a corner point

1. From the *Offset* menu, press **[6]** (or press **[v]** and **[REC/ENT]**) to select *CornerPt*.

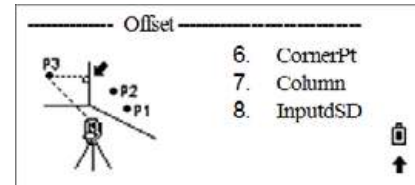

The *CornerPt* screen appears.

2. Take a distance measurement to the first prism (or target) on the wall. Press **[MSR1]** or **[MSR2]**.

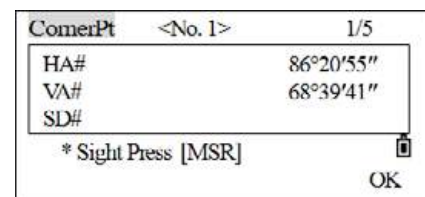
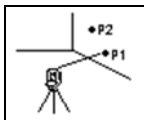

3. Sight a second point on the same wall as the first point measurement. Press **[MSR1]** or **[MSR2]**.

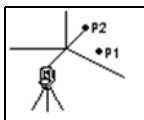

4. Sight the first point on the second wall. Press **[MSR1]** or **[MSR2]**.

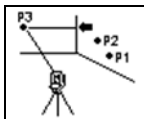

5. If the two walls are at right angles, press the **Calc** softkey to calculate the corner point by three points.
6. If you take a measurement to a fourth point, the corner point can be calculated as the intersection of two walls (P1-P2 and P3-P4). The default elevation is given by P4.

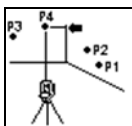

7. Enter a PT (and CD) value and press **[REC/ENT]**. The height of target (HT) defaults to the value used in the last measurement. The target point is calculated and recorded as an SS record.

## Calculating a column

1. On page 2 of the *Offset* menu, press **[7]** (or press **[v]** and **[REC/ENT]**) to select *Column*.
2. If a measurement has not been taken to the column before entering this function, a temporary measurement screen appears. Sight any point on the surface of the column and press **[MSR1]/[MSR2]**.
3. Press **[REC/ENT]**. If a prism is attached to the surface of the column for the distance measurement, press the **+SD** softkey to eliminate the offset error (from the attached point to the measured surface of the prism) before **[REC/ENT]** is pressed.
4. Sight one edge of the column.

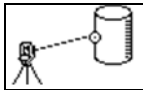
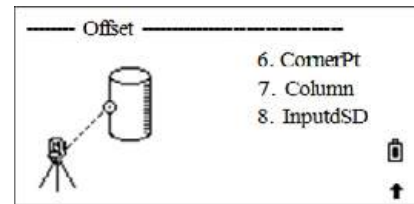

5. If a distance measurement to the center of the column is taken, press the **Calc** softkey to calculate the offset using one edge angle observation.
6. Press **[REC/ENT]** or the **OK** softkey. Sight the other edge of the column. It also calculates the coordinates of the center point and the radius of the circle.

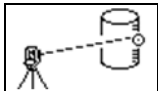

7. In the dialog, if the result is satisfactory, press the **OK** softkey, otherwise press the **Redo** softkey.
8. Enter a PT (and CD) value and press **[REC/ENT]**. The target point is calculated and recorded as an SS record.

**Note** – The calculated point (center of the circle) is stored as an SS record.

**Note** – If you press the **+SD** softkey before you sight Edge1, the input value is recorded at the end.

## Extending the slope distance

1. In page 2 of the *Offset* menu, press **[8]** (or press **[v]** and **[REC/ENT]**) to select *InputdSD*.
2. If a distance measurement is not taken before entering this function, a temporary measurement screen appears. Sight the target and press **[MSR1]/[MSR2]**.
3. Enter the slope distance. Any value from -99.99 through +99.99 m can be entered. Press **[REC/ENT]** to record the point.
4. Enter a PT (and CD) value and press **[REC/ENT]**. The target point is calculated and recorded as an SS record.

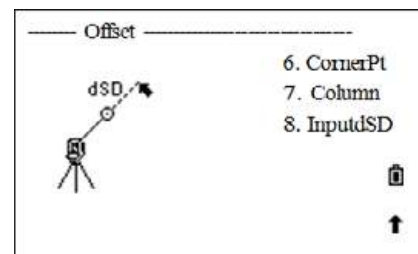

## Program Key

To display the *Program* menu, press **[PRG]**.

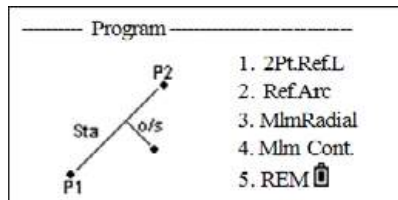

## Point refline

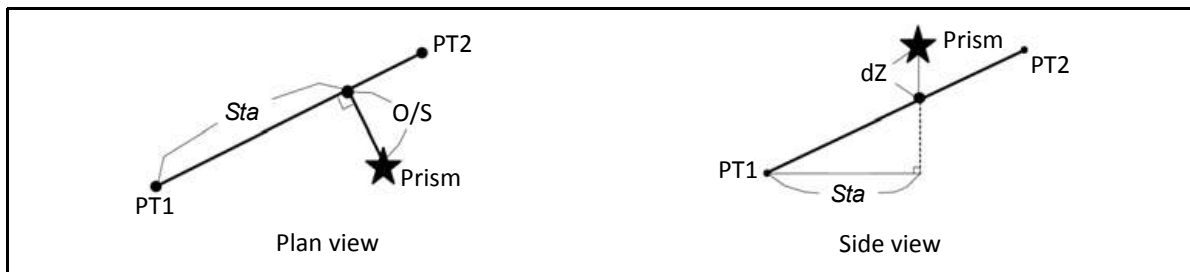

1. From the *Program* menu, press **[1]** (or press **[v]** and **[REC/ENT]**) to select *2Pt RefLine*.

The InputP1 screen appears.

2. Enter the first point for the reference line.
3. Enter the second point for the reference line.
4. Sight the target and press **[MSR1]** or **[MSR2]**.

After measuring, the results display

Sta      Horizontal distance from P1 to the measured point along the P1-P2 line

O/S      Horizontal offset from the P1-P2 line to the measured point

dZ      Vertical offset from the P1-P2 line to the measured point

5. Press **[REC/ENT]** to record the line.

Press **[v]** or the **DSP** softkey to switch between display screens.

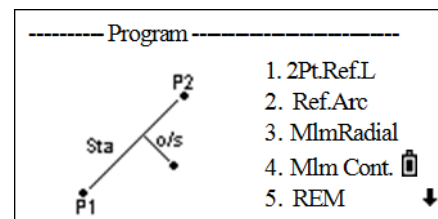

## Reference Arc

Measuring distance and offset values on the arc curve.

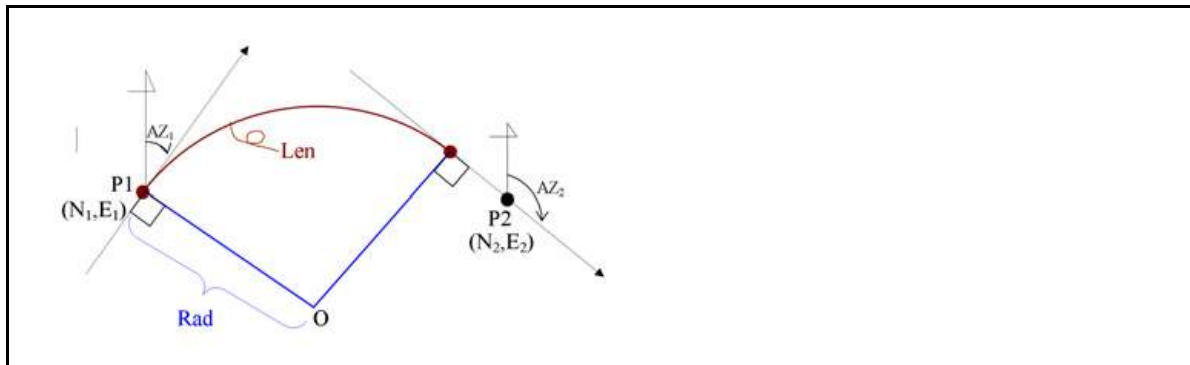

1. From the *Program* menu, press **[2]** (or press **[v]** and **[REC/ENT]**) to select *Ref.Arc*.

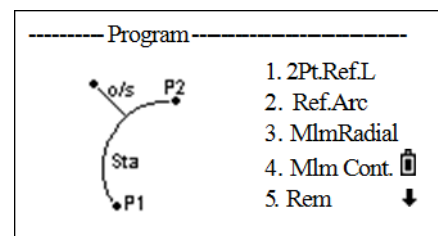

The *Arc Start* screen appears.

2. Enter the start of the curve point (P1) and the azimuth of its tangent line (AZ1).

- To enter P1 by direct measurement, press the **MSR** softkey.

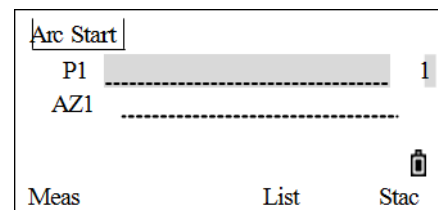

3. Choose a method to define the arc. The options are:

- Use *P2-AZ2* to define the arc. Enter the point name of P2 and azimuth of its tangent line (AZ2). P2 can be any point on the tangent line that is to exit the curve.
- Use *Rad-AZ2* to define the arc. Enter the radius and azimuth of its tangent line (AZ2). In the radius (Rad) field, enter a positive value for a clockwise curve. Enter a negative value for a counterclockwise curve.
- Use *Rad-Len* to define the arc. Enter radius and arc length. Similarly, in the radius (Rad) field, enter a positive value for a clockwise curve. Enter a negative value for a counterclockwise curve, as sh.

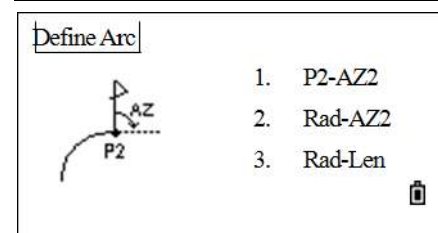

When all items are entered, the instrument calculates the curve. If the curve length (Len) is too large for a circle of the given radius, it is shortened. If the curve is reasonable, press the **[OK]** softkey to confirm or press the **[REDEF]** softkey to redefine.

4. Sight the center of prism, and press **[MSR1]** or **[MSR2]**.

After measuring, the results display:

Sta	Horizontal distance from P1 to the measured point along the P1-P2 line
O/S	Horizontal offset from the P1-P2 line to the measured point
dZ	Vertical offset from the P1-P2 line to the measured point

5. To record the point, press **REC/ENT**. The arc is stored in comment records.

Press **√** or the **DSP** softkey to switch between display screens.

## Remote distance measurement

This function measures the horizontal distance, vertical distance, and slope distance between two points.

rSD	Slope distance between two points
rHD	Horizontal distance between two points
rVD	Vertical distance between two points
rV%	Percentage of grade ( $rVD/rHD \times 100\%$ )
rGD	Vertical grade ( $rHD/rVD$ )
rAZ	Azimuth from first point to second point

There are two methods available:

- MImRadial (A-B, A-C). See MImRadial, page 81.
- MIm Cont. (A-B, B-C). See MIm Cont., page 82.



## MlmRadial

Measuring between the current and the first point measured.

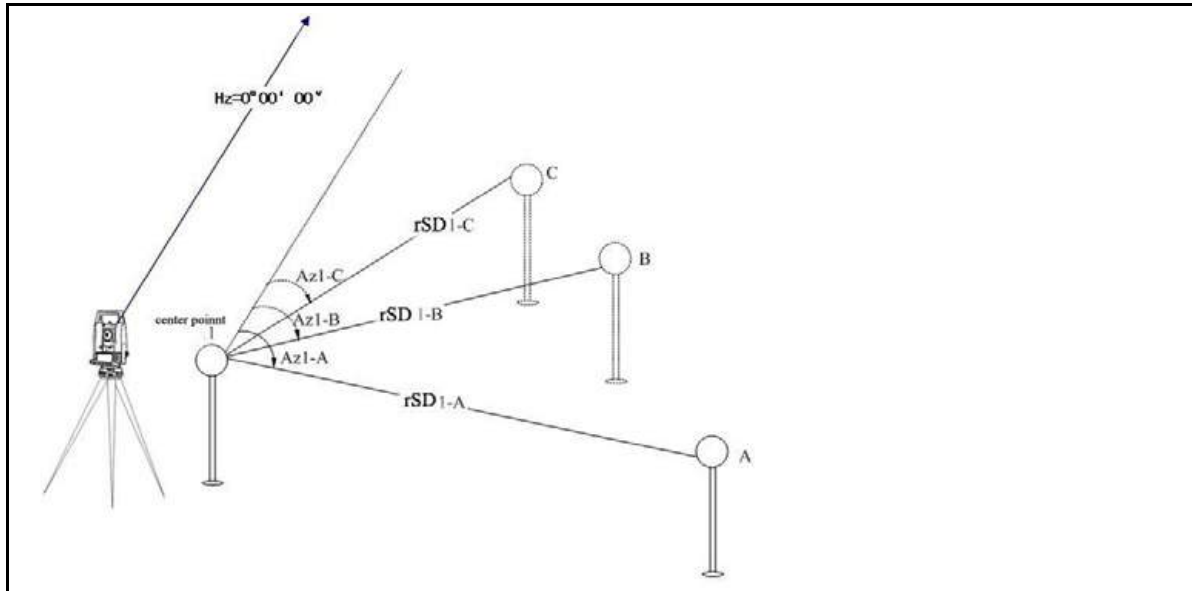

1. From the *Program* menu, press **[3]** (or press **[v]** and **[REC/ENT]**) to select *MlmRadial*.

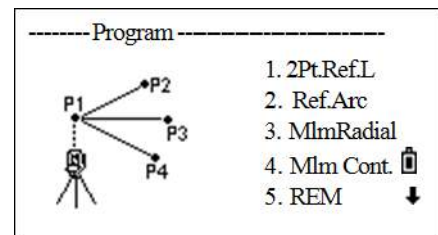

The *MlmRadial* screen appears.

2. Sight the first point and press **[MSR1]** or **[MSR2]**.  
The distance from the station point to the first point is displayed.
3. Sight the second point and press **[MSR1]** or **[MSR2]**. The distances between the first and second point are displayed.

rSD     Slope distance between two points  
rVD     Vertical distance between two points  
rHD     Horizontal distance between two points

4. To change display screens, press **[v]**.

rAZ     Azimuth from first point to second point  
rV%     Percentage of grade (rVD/rHD) × 100%  
rGD     Vertical grade (rHD/rVD)

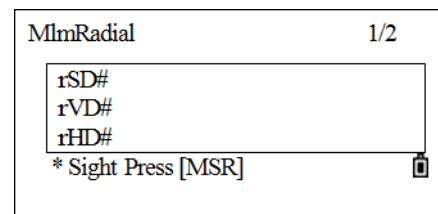

- To record the distance and angle information as a comment record, press **[REC/ENT]** in the 1/2 or 2/2 observation screen.

Default point numbers are displayed (STN=0, PT=1, PT=2, and so on). These point numbers can be changed.

- After recording, the display returns to the *MImRadial* screen. Sight the third point and press **[MSR1]** or **[MSR2]**. The distances between the first and third point are displayed.
- Press **[REC/ENT]** to record the distances between the first and third point.
- Repeat the procedure to calculate and record the distance between the first point and other points.

### MIm Cont.

Measuring between the current point and the immediately preceding point. Other operations are the same as MImRadial.

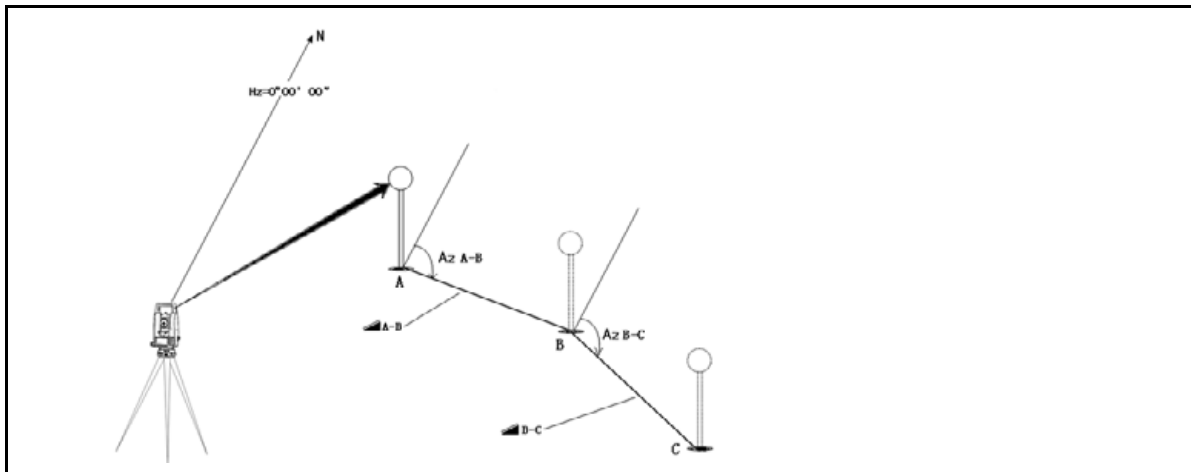

- From the *Program*, press **[4]** (or press **[v]** and **[REC/ENT]**) to select *MIm Cont.*.

-----Program-----	
	1. 2Pt.Ref.L
	2. Ref.Arc
	3. MImRadial
	4. MIm Cont.
	5. REM

The *MIm Cont.* screen appears.

- Sight the first point and press **[MSR1]** or **[MSR2]**.

The distance from the station point to the first point is displayed.

MIm Cont.	1/2
rSD#	
rVD#	
rHD#	
* Sight Press [MSR]	

3. Sight the second point and press **[MSR1]** or **[MSR2]**. The distances between the first and second point are displayed.

rSD     Slope distance between two points  
 rVD     Vertical distance between two points  
 rHD     Horizontal distance between two points

4. To change display screens, press **[V]**.

rAZ     Azimuth from first point to second point  
 rV%     Percentage of grade (rVD/rHD) × 100%  
 rGD     Vertical grade (rHD/rVD)

5. To record the distance and angle information as a comment record, press **[REC/ENT]** in the 1/2 or 2/2 observation screen.

Default point numbers are displayed (STN=0, PT=1, PT=2, and so on). These point numbers can be changed.

6. After recording, the display returns to the *MIm Cont.* screen. Sight the third point and press **[MSR1]** or **[MSR2]**. The distances between the second and third point are displayed.
7. Press **[REC/ENT]** to record the distances between the second and third point.
8. Repeat the procedure to calculate and record the distance between the third and fourth point, and so on.

## Remote elevation measurement (REM)

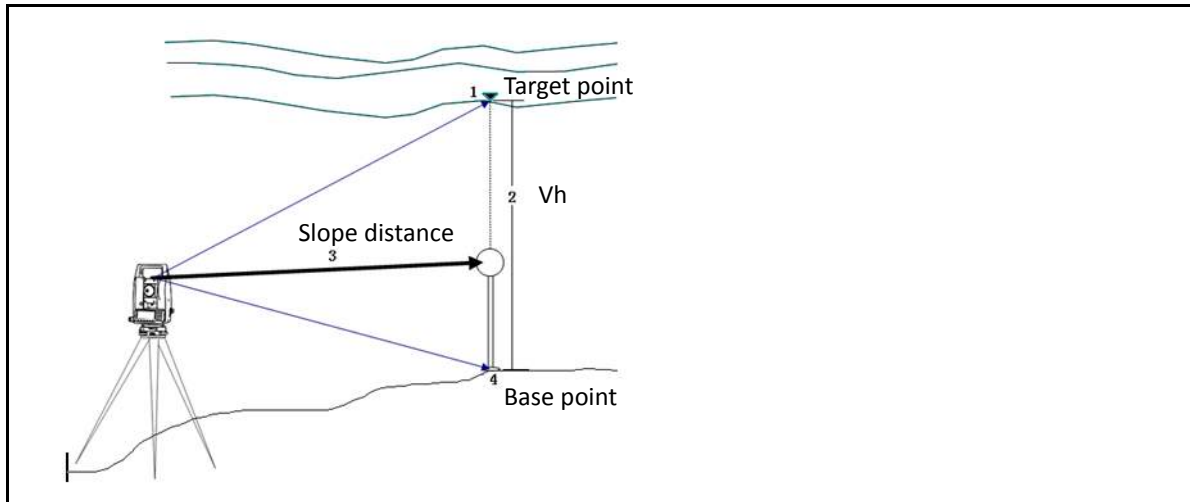

1. From the *Program* menu, press **[5]** (or press **[v]** and **[REC/ENT]**) to select *REM*.

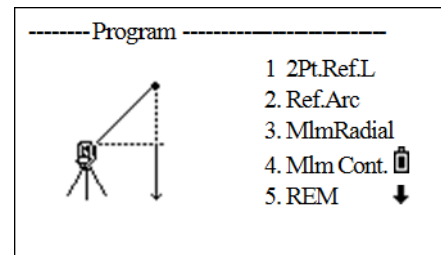

The *REM* screen appears.

2. Enter the height of target (HT).
3. Sight the target point and press **[MSR1]** or **[MSR2]**. The measurement results are displayed.
4. Loosen the vertical clamp, and turn the telescope to aim at the target point.

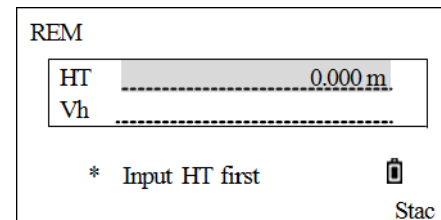

The difference in elevation ( $V_h$ ) is displayed.

5. Press **[REC/ENT]** to update the height of target.

## 2-PT reference plane (V-plane)

Measuring distance and offset values on a vertical plane.

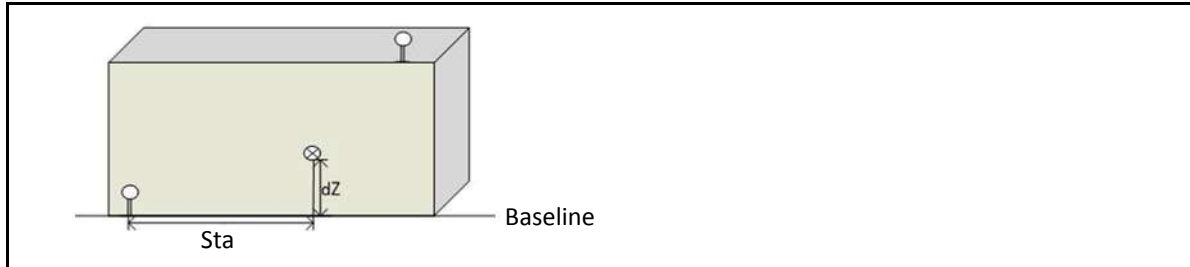

1. From the *Program* menu, press **[6]** (or press **[v]** and **[REC/ENT]**) to select *V-Plane*.
2. Enter the first point (P1) to define the plane.
3. Enter the second point (P2) to define the plane and then press **[REC/ENT]**.

Once the plane is defined, the calculated Sta and dZ values are updated as the telescope is moved. No distance measurement is required.

The results displayed are:

Sta      Horizontal distance from P1 to the target point along the baseline  
dZ      Vertical distance from P1 to the target point

Press **[v]** to display other pages.

4. To record the point, press **[REC/ENT]** on any screen.
5. Enter a value in the PT and CD fields. Press **[REC/ENT]**.

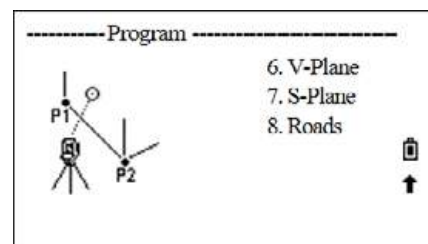

## 3-PT reference plane (S-Plane)

Measuring distance and offset values on a sloping plane.

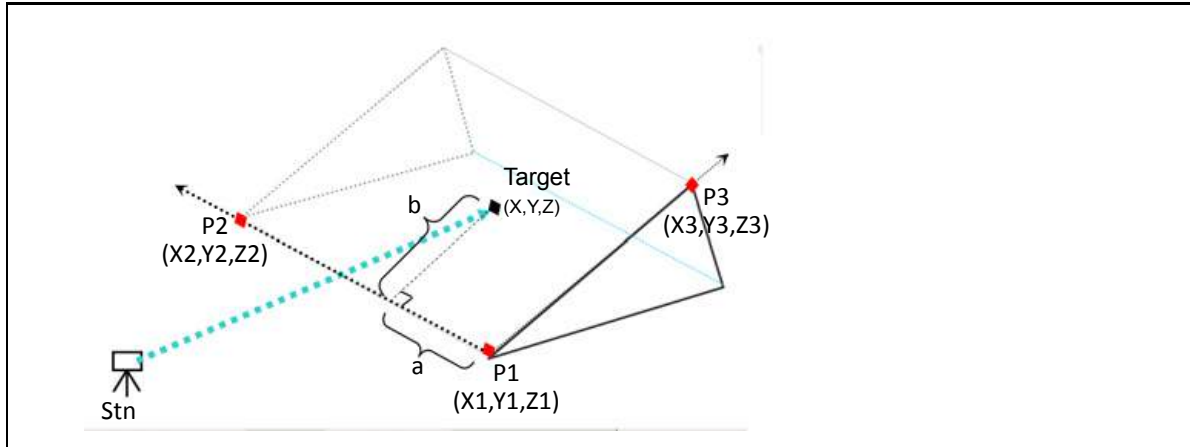

1. From the *Program* menu, press **7** (or press **v** and **REC/ENT**) to select *S-Plane*.
2. Enter the first point (P1) to define the slope plane.
3. Enter the second point (P2) on the plane.
4. Enter the third point (P3) on the plane. If the **2Pt** softkey is pressed here, the program defines the plane by P1 and P2.

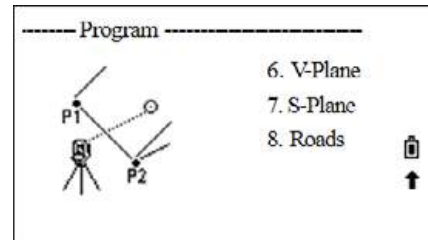

Once the plane is defined, the calculated *a* and *b* values are updated as the telescope is moved. No distance measurement is required.

- a* Distance between P1 and the point that is perpendicular to the target point along the P1-P2 line  
*b* Length of the perpendicular line from the target point to the P1-P2 line

Press **v** to display other screens as required.

5. To record the point, press **REC/ENT** on any screen.
6. Enter a value in the PT and CD fields. Press **REC/ENT**.

**Note** – If the plane is defined by two points (by selecting the **2Pt** softkey), the vertical plane is the same as the plane used in the *V-Pln* function, but the indicating factors are *Sta* and *dZ*, not *a* and *b*.



## Roads

This program enables the easy definition of a line or curve or spiral as a reference for measurements and stake outs. It supports chainages (stationing), as well as incremental stakeouts and offsets.

Before starting road design and stakeout, the job, station, and orientation should all be set first.

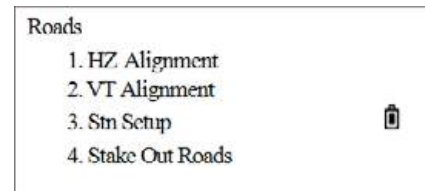

### Defining a horizontal alignment

Horizontal alignment consists of the following elements: start point, line, curve and spiral.

To define a horizontal alignment, first input detailed information (Chainage, N, E coordinate) for the start point.

The serial number and the amount of the present horizontal alignment are displayed on the upper right corner of the screen.

The start point consists of the start chainage and N, E coordinate of start point. Enter these details, and press **[REC/ENT]** to display the main line input screen.

The screen displays the current chainage, the azimuth angle of the tangent on the chainage, and the function keys for establishing new line. The system provides four functions: defining line, curve, spiral, and point.

Select a function key, enter the detailed information for the chainage and the alignment elements will be created. Press **[REC/ENT]** to calculate the new chainage and azimuth angle automatically and return to the alignment definition main menu. You can now define other line types.

1. In the second page of the *Program* menu, press **[8]** (or press **[v]** and **[REC/ENT]**) to select *Roads*.
2. Select **1. HZ Alignment** to open the define HZ Alignment function.
3. Select **1. Define HZ AL**.
4. Enter the chainage of the start point and the N, E coordinates of this point. After finishing one item, press **[REC/ENT]** to move to the next item.

The *Define HZ AL* screen appears.

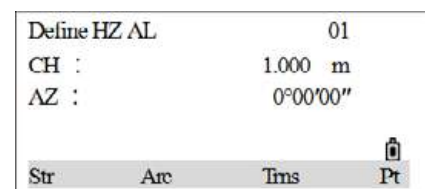
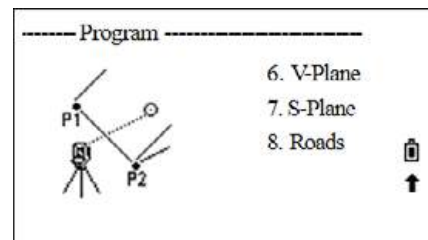

## Straight Line

When the start point or other line type is defined, the straight line can be defined. A line consists of azimuth angle and distance. The distance value cannot be negative.

1. In the *Define HZ AL* screen, press the  $\text{Str}$  softkey to enter the straight line definition menu.
2. After entering the AZ angle, press  $\text{REC/ENT}$  to go to the next input item.
3. Enter the length of the line and then press  $\text{REC/ENT}$ .

The display returns to the *Alignment Definition* main menu, and displays the chainage of the line end point and azimuth of this point. Curves can now be defined.

4. When the line is in the middle of the road, the azimuth angle of the line is calculated according to the previous elements. If the user is to change this azimuth angle, the new azimuth angle can be entered manually.

## Arc

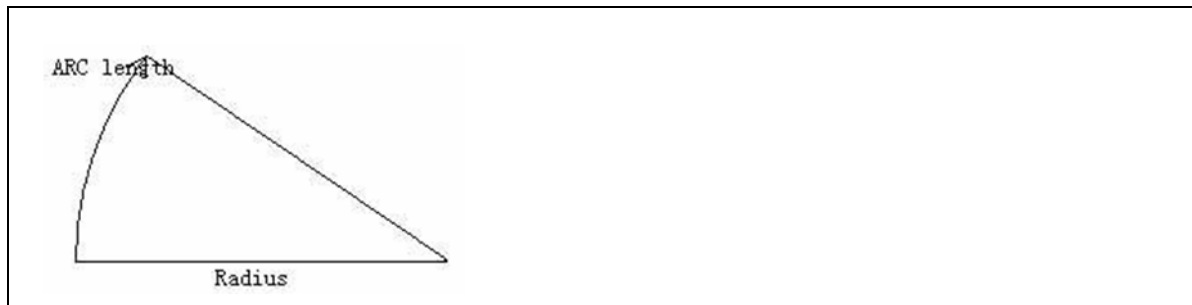

In the *Define HZ AL* menu, press the  $\text{Arc}$  softkey to define the curve/arc. A curve consists of arc length and radius. The Arc radius value rules: In the forward direction of the curve, when the arc turns right, the radius value is positive; when the arc turns to the left, the radius value is negative. The arc length cannot be negative nor can it be longer than the circumference.

Define HZ AL	01
CH :	1.000 m
AZ :	0°00'00"
Str	Arc
Tms	Pt

1. In the *Define HZ AL* screen, press the  $\text{Arc}$  softkey to enter the arc definition screen.
2. Enter the input radius and arc length, and press  $\text{REC/ENT}$  to record this data.

The display returns to the *Alignment Definition* main menu, and displays the chainage of the end point of the arc and azimuth at this point.



## Transition

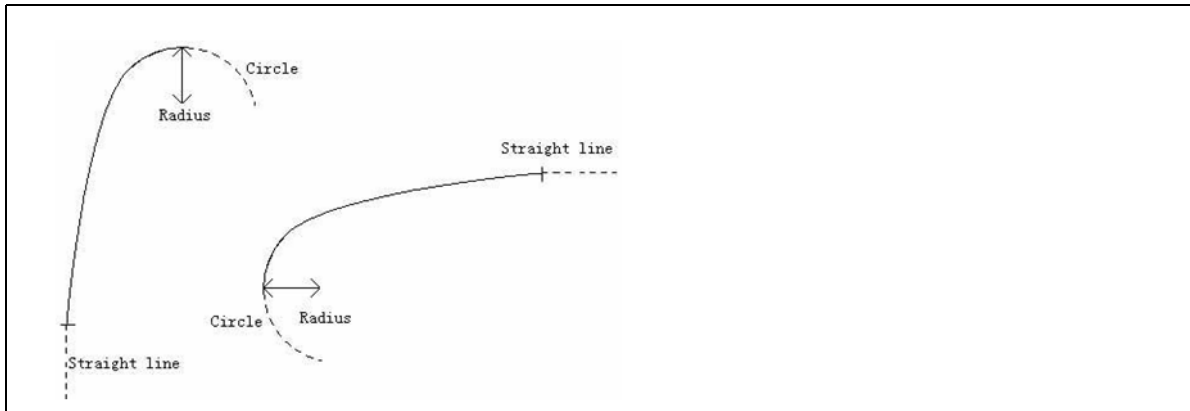

A transition curve consists of the minimum radius and arc length. Transition radius value rules is the same as the arc radius value rule; that is, the arc length cannot be negative.

To define the transition curve:

1. In the *Define HZ AL* screen, press **Trns**.

Define HZ AL	01
CH :	1.000 m
AZ :	0°00'00"
Str	Arc
Trns	Pt

The *Transition Definition* screen appears.

2. Enter the radius and arc length, and press **REC/ENT** to record this data.

The display returns to the *Alignment Definition* main menu, and displays the chainage of end point of the transition and azimuth at this point.

Transition	02
Rad	-----
Len	-----

**Point**

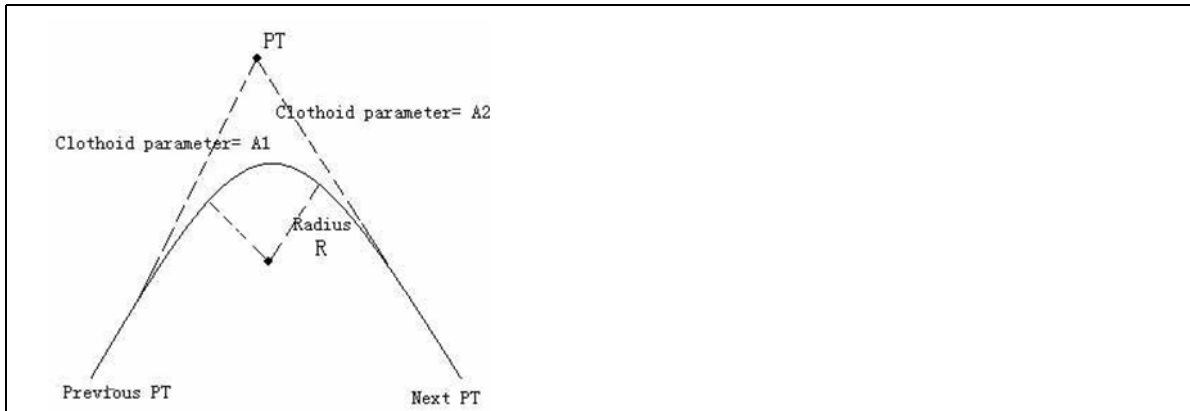

A point element consists of coordinate, radius and spiral factors A1 and A2. Radius, A1 and A2 cannot be negative. When the radius is entered, an arc with the specified radius is inserted between the current point and the next point. When spiral factors A1 or A2 are entered, a spiral curve with specified length is inserted between the line and arc.

**Note** – If A1, A2 are entered according to the lengths L1, L2 of the spiral, the following formulas are used to calculate A1 and A2.

$$A_1 = \sqrt{L_1 \text{radius}}$$

$$A_2 = \sqrt{L_2 \text{radius}}$$

To define a point:

1. In the *Define HZ AL* screen, press the **Pt** softkey.

Define HZ AL	01
CH :	1.000 m
AZ :	0°00'00"
	☰
Str	Arc
	Trns
	Pt

The *Pt* screen appears.

2. Enter the N and E coordinates, radius and A1, A2 and then press **(REC/ENT)**.

The display returns to the *Define HZ AL* screen.

Pt	02
N	0.000 m
E	0.000 m
Rad:	0.000 m
A1 :	0.000
A2	0.000

## Editing horizontal alignment data

Horizontal alignment data can be edited. The data can be edited using the following softkeys:

- **Strt**: Go to the beginning of the file, and display the initial alignment data.
- **End**: Go to the end of the file, and display the final alignment data.
- **Prev**: Display the previous point data.
- **Next**: Display the next point data.

After entering any edits, press **REC/ENT** to record the edited data and move into the input screen for the next point. To quit without saving data, press **ESC**.

1. In the *HZ Alignment* screen, press **2** (or press **v** and **REC/ENT**) to select **Edit HZ AL**.

The *Start Pt* screen appears showing the start point data.

2. Press the **Next** softkey to find the alignment data to be edited.
3. Enter the new data and then press **REC/ENT**.
4. The screen displays the modified new data. Press **Prev** or **Next** to view and modify other data.

## Receiving horizontal alignment

1. From the *HZ Alignment* screen, press **3** (or press **v** and **REC/ENT**) to select **Receive HZ AL**.

The *Receive HZ AL* screen appears.

2. Press the **Comm** softkey to set the communication parameters, making the parameters consistent with the settings in the communication software. If not transmitting, press **Abort**.
3. Press **v/^** to move the cursor to each parameter, press **</>** to select options for each item. After finishing settings, press **REC/ENT**.
4. After settings, press **Strt** to receive.
5. After receiving data, the program finishes automatically, and returns to the *HZ Alignment* menu.

HZ Alignment	
1. Define HZ AL	
2. Edit HZ AL	
3. Receive HZ AL	
4. Delete HZ AL	

Start Pt		01/05
CH	10.000	
N	10.000 m	
E	10.000 m	
End		Next 

Straight		02/05
AZ	30°00'10"	
Len	10.000 m	
Strt	End	Prev Next 

HZ Alignment	
1. Define HZ AL	
2. Edit HZ AL	
3. Receive HZ AL	
4. Delete HZ AL	

<Comm >	
Baud:	1200
Data.L:	8
Parity:	None
Stop :	1

## Deleting horizontal alignment data

The horizontal alignment data in the internal memory can be deleted.

1. From the *HZ Alignment* screen, press **4** (or press **v** and **REC/ENT**) to select *Delete HZ AL*.

The program displays the message *Delete HZ AL \*Sure?*.

2. Press **OK** to delete horizontal alignment data. All the horizontal alignment data in internal memory will be deleted. The system returns to *HZ Alignment* screen where the horizontal alignment data can be redefined.

Press **Abort** if the data is not to be deleted.

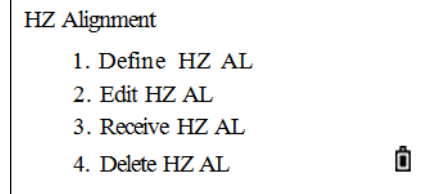

## Defining vertical alignment

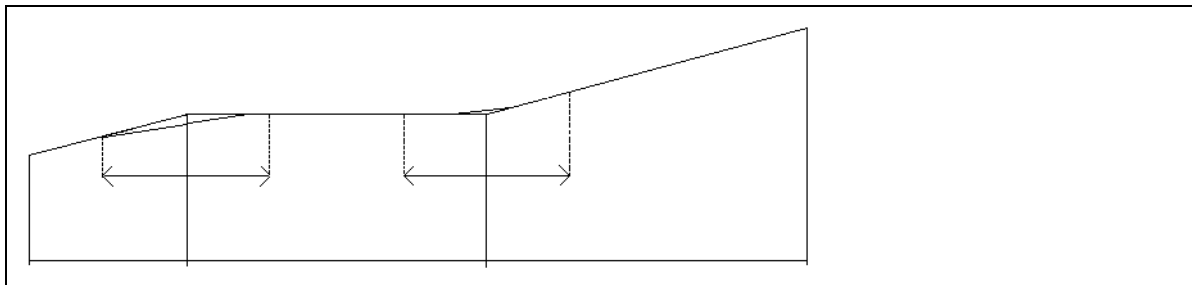

Chainage	1000	1300	1800	2300
Height	50	70	60	90
Curve length	0	300	300	0

A vertical alignment consists of a series of intersections, including a chainage, height and curve length. The length of the start point and the end point must be zero.

Intersections can be entered in any order. After entering data for one point, press **REC/ENT** to save it and go to the next input screen. Press **ESC** to quit without saving.

1. From the *Roads* menu, press **2** (or press **v** and **REC/ENT**) to select *VT Alignment*.
2. Press **1** or select *Define VT AL*.
3. Enter the chainage, elevation, and length and then press **REC/ENT**.

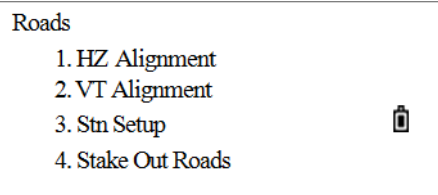

The length of the start point and the end point must be 0.

The message *Complete* displays at the bottom of the screen. When this alignment data is saved, the display returns to the *Define VT AL* screen to enable the next alignment to be entered.

## Editing vertical alignment data

Vertical alignment data can also be edited. The actual editing steps are similar to that of editing horizontal alignment.

1. From the *VT Alignment* screen, press **[2]** (or press **[v]** and **[REC/ENT]**) to select *Edit VT AL*.  
The screen displays the first vertical alignment.
2. Enter the new data and then press **[REC/ENT]**.
3. The screen displays the modified new data. Press **Prev** or **Next** to view and modify other data.

## Receiving vertical alignment data

The method of Receiving VT AL data is same as Receiving HZ AL data. See Receiving horizontal alignment, page 91.

## Deleting vertical alignment data

The vertical alignment data in internal memory can be deleted. The operation is described below.

1. From the *VT Alignment* screen, press **[4]** (or press **[v]** and **[REC/ENT]**) to select *Delete VT AL*.  
The program displays the message *Delete VT AL. \*Sure?*.
2. Press **OK** to delete VT AL. All the vertical alignment data in internal memory will be deleted. The system returns to *VT Alignment* screen where the vertical alignment data can be redefined.  
Press **Abort** if it is not to be deleted.

## Station setup

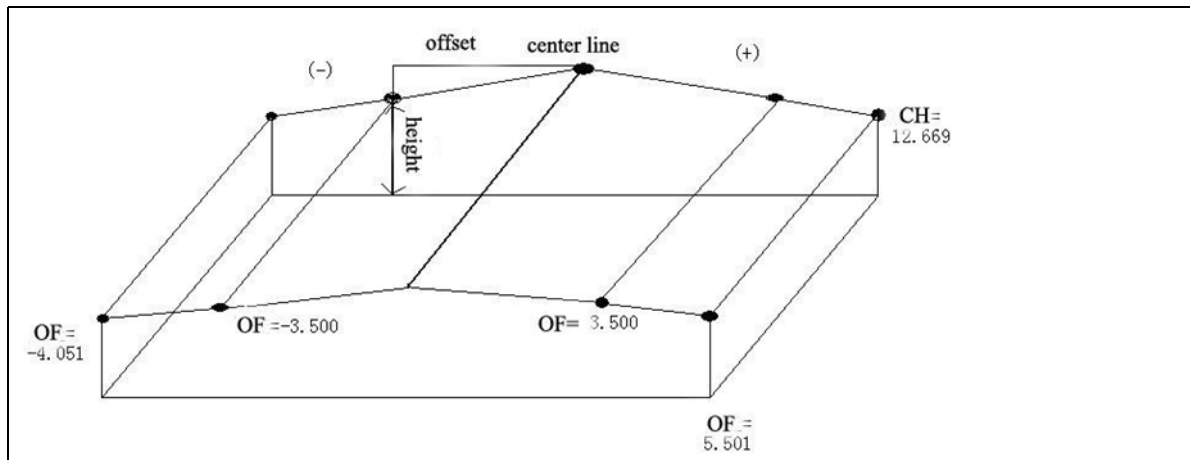

Chainage can be used to set up a station when there is horizontal alignment data in internal memory.

1. From the *Roads* menu, press **3** (or press **V** and **REC/ENT**) to select *Stn Setup*.
2. When there is horizontal alignment data in memory, press **CH** to set up the station.

### Roads

1. HZ Alignment
2. VT Alignment
3. Stn Setup 
4. Stake Out Roads

**Note** – For the other method to set up station, see *Station key*, page 54.

3. Enter the chainage and press **REC/ENT**. Make sure that the input chainage is on the designed horizontal alignment. Press **F T** to set up station by point function (see *Station key*, page 54).
4. In the **OF** item, enter the offset of the chainage to the center line and press **REC/ENT**.
5. The screen displays detailed data about the chainage. Enter the height of the instrument and then press **REC/ENT**.
6. Set the backsight point. The backsight can also be set using chainage.

**Note** – This is the same as *Station key*, page 54.

## Stake out roads

To stake out the alignment, you must first define the alignment type.

You can define the horizontal alignment in two ways:

- Create it in the computer using the data communication software provided with the instrument.
- Manually enter it on the instrument in the *Roads* menu.

It is not necessary to define the vertical alignment data, unless it is required to compute cut and fill. The definition method is similar to that of horizontal alignment. Rules of alignment stake-out data are as follows:

- Offset left: Horizontal distance between the offset point left and the center line.

- Offset right: Horizontal distance between the offset point right and the center line.
- Vertical Difference Left (right): Vertical difference between left (right) offset and the center line point.

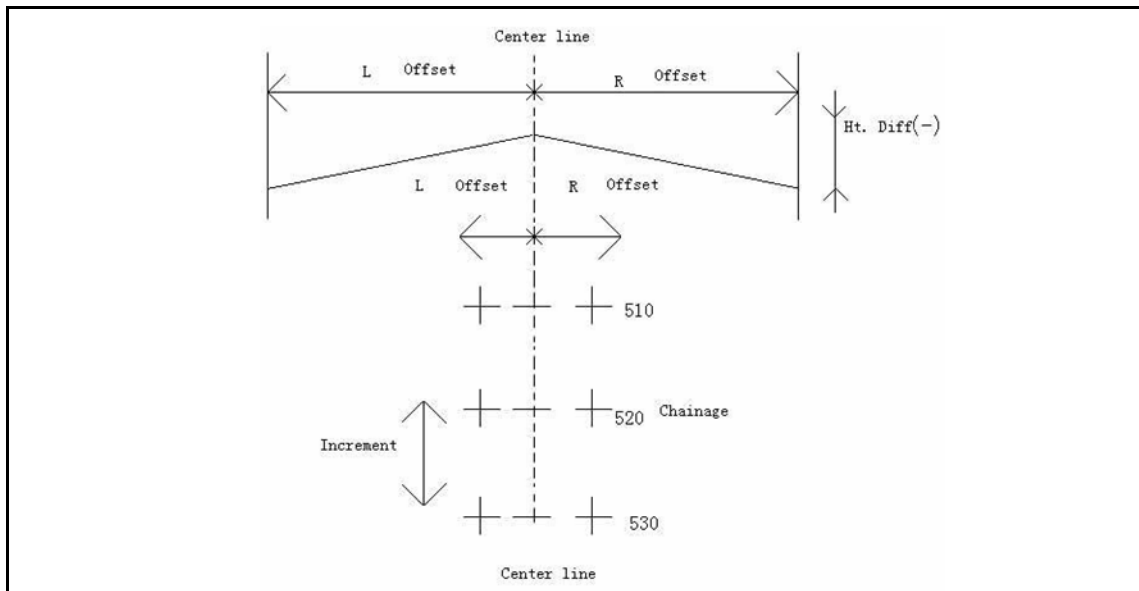

**Tip** – In the stakeout process, points on the center line should be staked first, then the offset points on both sides of the center line.

The method to stakeout alignment is similar to that of point stake-out, with three methods available, in this example, taking points on the center line.

1. From the *Roads* menu, press **[4]** (or press **[v]** and **[REC/ENT]**) to select *Stake*.
2. This displays the alignment stake-out data. Enter the start chainage, chainage increment, and the horizontal distance between the offset point and center line. Height distance is required if cut/fill data is to be staked out.

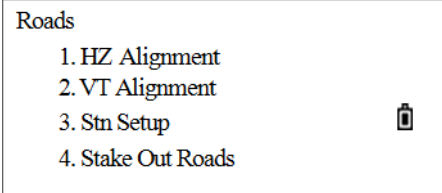

- O/S L: Horizontal distance between the left offset point and center line.
  - O/S R: Horizontal distance between the right offset point and center line.
  - dVD L: Height difference between the left offset point and center line
  - dVD R: Height difference between the right offset point and center line.
3. After the data is entered, press **[REC/ENT]** to enter the main stakeout point and offset screen. The stake-out data for the center line at the start chainage is displayed.
  4. Stake out points on the center line first, and then press **LOFS** (or **ROFS**) to stake out the left (or right) offset.

When **LOFS** (or **ROFS**) is pressed, the chainage, offset and height difference is displayed.

5. The chainage and height difference can be manually entered here.
  - Offset is negative: Offset point is on the left of center line.
  - Offset is positive: Offset point is on the right of center line.
6. When the chainage and the offset to be staked have been entered, press **REC/ENT** to move into the stake-out screen. Press **REC/ENT** to save the coordinates of the stake-out point. The program automatically enters into the *Stake Out Roads* screen. (No save, press **ESC**).
7. Enter the *Stake Out Roads* screen. The steps are the same as point stake-out. Rotate the instrument until the dAZ displays 0°00'00".
8. Sight the target and then press **MSR1** or **MSR2**.
9. After measuring, the deviation value between the measured point and the stakeout point is shown.
  - dHA: Difference in horizontal angle to the target point
  - R/L: Right/Left (Lateral error)
  - IN/OUT: In/Out (Longitudinal error)
  - CUT/FIL: Cut/Fill
10. Move the rodperson to the target position, making R/L and IN/OUT to display 0 m.
 

An up arrow signifies to move away from the station (OUT).

An down arrow signifies to move towards the station (IN).

When both R/L and IN/OUT display 0m, it indicates the prism is on the stakeout point.

The fifth line shows the cut/fill data.
11. After staking out, press **REC/ENT** to record the stakeout point. PT defaults to the last recorded PT+1. Input code (CD) if necessary. Press **REC/ENT** to record the point.

### Explanation of the Alignment Stakeout screen

**LOFS:** This softkey is used to stake out the left offset. Press it to display the offset and the height difference left of the center line chainage.

**ROFS:** This softkey is used to stake out the right offset. Press it to display the offset and the height difference right of the center line chainage.

**+CHG:** This softkey is used to increase the chainage.

**–CHG:** This softkey is used to decrease the chainage.



## Slope stakeout

Slope Stakeout can be launched as part of the Alignment StakeOut. The horizontal and vertical alignments must be defined in the *Roads* menu first. In the *Stakeout Alignment* main screen, press **Menu** to open the slope stake-out function.

The cut/fill value that is input here is as a ratio.

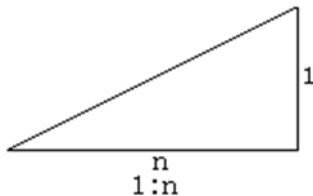

The cut/fill data can be entered through left and right slopes. In terms of cut/fill, use positive symbol to input the required slope, the software selects an appropriate slope in the list according to the actual position of the point.

Cut/fill is decided via the estimated height of the hinge point. If the height is above the hinge point, the cut slope is used; otherwise the fill slope is used.

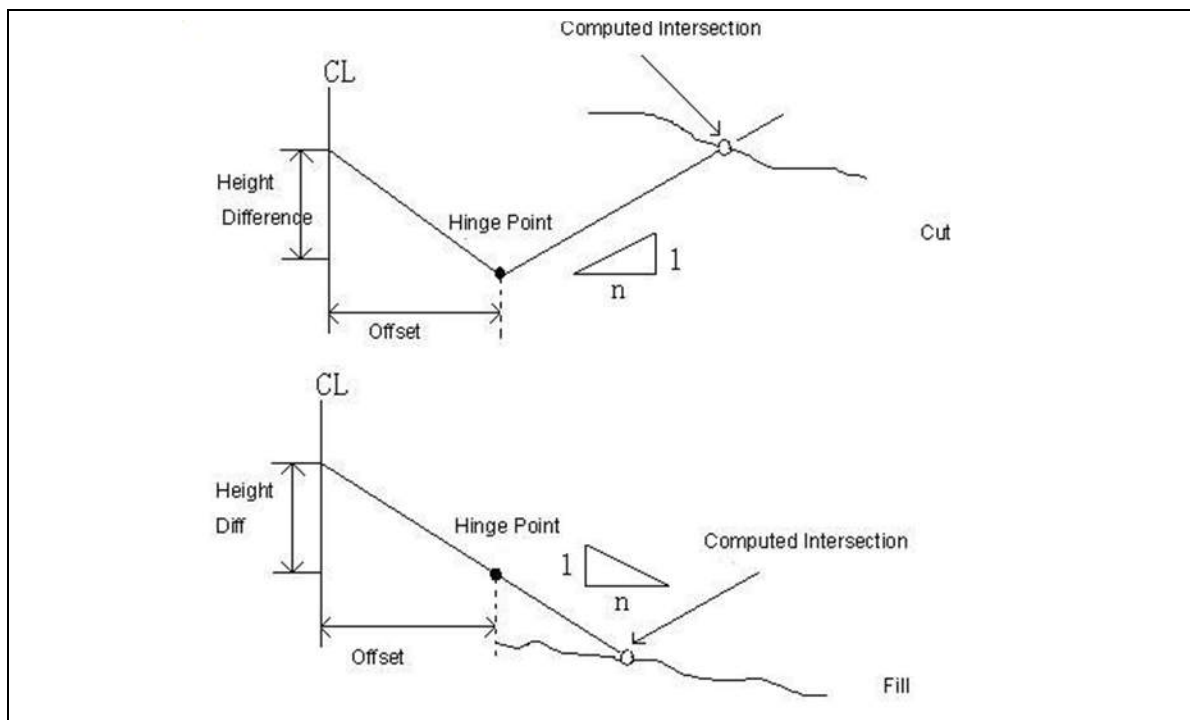

1. In the *Stake-out* main menu, enter (or select) the chainage at which to slope stake out. Press **[MENU]** to start.
2. Enter the ratio of left and right slopes to be cut or filled. After each item is entered, press **[REC/ENT]**.

CH:	.....	1.000
O/S:	.....	0.000 m
dVD:	.....	0.000 m
* Press <b>[MENU]</b> Slope SO		
LOFS	ROFS	+CHG -CHG

3. When all data is entered, select the left (or right) slope to be staked out.
4. This enters the *Slope Stake* screen. Enter the prism height, sight the point that is to be intersected near the slope, and press **[MSR1]** or **[MSR2]** to start the slope stakeout.

The system will select the appropriate slope from the data entered in the previous step. The intersected point is calculated using the height of the measured point as the horizontal datum plane. The list displays the offset between the measured point and the calculated point.

The slope stakeout method is similar to that of point stakeout. When both IN/OUT and L/R values are zero, the stakeout position is located.

5. Once staking out this point is finished, press **[ESC]** to return to the main *Slope Stakeout* screen. Enter the new slope to be staked out and continue to stakeout using the same approach.

**Note** – *If the surface crosses through the hinge point, the intersection cannot be calculated.*

**Note** – *If the cut/fill values of the calculated point are zero, the cut/fill value is not displayed.*

## COD key

In the Basic Measurement screen, press the COD key **[5]** to change the default feature code that will appear in the CD item when a point is recorded.

To update the default code:

1. In the Basic Measurement screen, press **[5]**.  
A screen appears for entering the feature code.
2. Do one of the following:
  - Enter the CD manually. (The input code(s) are entered in the stack in chronological order).
  - Select a code by pressing the **List** softkey. To add, delete, or edit codes in the list, see Point name list and code list, page 119.
  - Select a code by pressing the **Stack** softkey. If manual entry is possible, the **Stack** code can be used. The stack shows the last 20 point names used in chronological order from last used to first used.
3. Press **[REC/ENT]** to return to the Basic Measurement screen.
4. Press **[REC/ENT]** to see if the default code is the setting you just selected.

For more on methods used to enter codes, see Adding a code, page 120.

## DAT key

When the **DAT** key is pressed in the Basic Measurement screen or in observation screens in functions such as Stakeout, 2Pt RefLine, and so on, the data in the current job is displayed.

Hold the key down for one second in the Basic Measurement screen or an observation screen to display the *Data Type* screen. Through this screen you can change the type of data that is assigned to the **DAT** key.

To change the type of data that is assigned to **DAT**, in the Menu screen, select *6.1 Sec* and then select **5** (Data).

For more information, see Data, page 112.

## USR 1/USR2 keys

If a certain function is used frequently in the field, it can be assigned to the **USR1** or **USR2** key. Whenever a **USR** key is pressed, the function that is predefined is activated directly.

The following functions can be assigned to the **USR** keys:

- Input HT
  - BS Check
  - TGT
  - Cogo→
  - Offset→
  - Program→
  - Temp&Press
  - Note
  - Point Laser
  - Direction Laser
  - (none)
1. In the Basic Measurement screen, press **USR1/USR2** for 1 sec. The function list for the **USR** key appears.
  2. Press **↓/↑** to highlight the function and then press **REC/ENT** to select it.

**Note** – If an item on the list has an arrow beside it, and this item is selected, the whole menu is assigned to the **USR** key. To assign a specific function from the sub-menu, press **↓/↑** to highlight the function. Then press **REC/ENT** to select it.

The screen returns to the Basic Measurement screen—the current predefined function is indicated by an asterisk (\*) beside the function name. Once a function is assigned to a **USR** key, it is activated directly whenever that key is pressed in the Basic Measurement screen.

# Menu Key

## In this chapter:

- Job
- Coordinate Geometry (COGO) calculations
- Settings
- Data
- Communication
- 1 Sec Keys
- Date and time
- Format
- Information

To display the main menu, press the **MENU** key.

----- Menu -----	
1. Job	6. 1 Sec.
2. Cogo	7. Adjust
3. Set	8. Time
4. Data	9. Format
5. Comm	10. Info

# Job

## Opening a job

1. From the main menu, press **1**.

The *JobMgr* screen appears.

If there are no jobs stored, the *Create Job* screen appears. See *Creating a new job*, page 101.

2. Press **▲** or **▼** to move up or down the job list. Press **REC/ENT** to open the highlighted job.

JobMgr:			
* TOPO11		07-01-20	
@ MQ		07-01-25	
STOUT		07-01-25	
SURVEY		07-01-25	📄
New	Del	Ctrl	Info

When you open a job, all job settings are automatically changed to match those used in the open job.

3. The program sets the job as the current job and returns to the Basic Measurement screen.

The following symbols are used:

Symbol	Meaning
*	Current job
@	Control job
!	Some of the job settings are different from the current job

## Creating a new job

1. In the *JobMgr* screen, press the **New** softkey.

JobMgr:			
* TOPO11		07-01-20	
@ MQ		07-01-25	
STOUT		07-01-25	
SURVEY		07-01-25	📄
New	Del	Ctrl	Info

The *Create Job* screen appears.

2. Enter a job name (no more than eight characters) and then press **REC/ENT**.
3. To:
  - Confirm creating a new job, press the **OK** softkey or **REC/ENT**.
  - Re-enter a name, press the **ABRT** softkey.
  - Check the job settings, press the **SET** softkey.

Create Job	
Job:	_____ A
📄	
*Max 8 char	

**Note** – It is not necessary to change the last settings. The current settings will apply to the new job when you press the **OK** softkey or **REC/ENT** to create a new job.

## Job settings

The following settings are set when a job is created, and cannot be changed. This is different to other temporary settings. This ensures that the data in a job is correctly stored in the database, and that all necessary corrections are applied when each record is stored.

Scale Factor	0.99000 to 1.001000
T-P crn	ON, OFF
SeaLevel	ON, OFF
C&R crn	OFF, 0.14, 0.200
Angle	DEG, GON, MIL
Dist.	Meter, USA Feet, USA Inch, IntlFeet, IntlInch
Temp.	°C, °F
Press	hPa, mmHg, inHg
VA 0	Zenith, Verticl, Vert ±90°
AZ 0	North, South
Order	NEZ, ENZ
HA	Azimuth, 0 to BS

To change the setting in the selected field, press  $\leftarrow$  or  $\rightarrow$ .

To move between fields, press  $\uparrow$  or  $\downarrow$ . Alternatively, to move to the next field, press  $\boxed{\text{REC/ENT}}$ .

To automatically create a new job, press  $\boxed{\text{REC/ENT}}$  in the last field (HA).

## Deleting a job

1. In the Job list, move the cursor to the job to be deleted by pressing the  $\uparrow$  or  $\downarrow$  key.

JobMgr:			
* TOPO11		07-01-20	
@ MQ		07-01-25	
STOUT		07-01-25	
SURVEY		07-01-25	
New	Del	Ctrl	Info

2. Press the DEL softkey. A confirmation screen appears.
3. Confirm that this is the job to be deleted. Press  $\boxed{\text{REC/ENT}}$  or the OK softkey.

To cancel the deletion and return to the previous screen, press  $\boxed{\text{ESC}}$  or the  $\boxed{\text{Abt}}$  softkey.

Del Job	
Job:	STOUT
* Sure?	
Abt	OK

## Setting the control job

If searching for a point when a control job is specified, and the system cannot find the point in the current job, the control job is also searched. If the point is found in the control job, it is copied to the current job as a UP record.

A control job has the same format as a standard job. It can be opened and modified like any other job, and it can be used to record any measured data.

1. Highlight the job to be used as a control job by pressing the  $\uparrow$  or  $\downarrow$  key.

Job Mgr:			
* TOPO11	07-01-20		
@ MQ	07-01-25		
STOUT	07-01-25		
SURVEY	07-01-25		📄
New	Del	Ctrl	Info

2. Press the **Ctrl** softkey. A confirmation screen appears.
3. To confirm, press **REC/ENT** or the **OK** softkey.

Ctrl job<ON>
Job: STOUT
*Set Ctrl job?
Abrt
OK

If a control job is already assigned, the newly assigned control job replaces it as the control job.

4. To clear the control job, highlight the current control job in the job list and then press the **Ctrl** softkey.

Job Mgr:			
* TOPO11	07-01-20		
MQ	07-01-25		
@ STOUT	07-01-25		
SURVEY	07-01-25		📄
New	Del	Ctrl	Info

## Displaying job Information

1. Highlight the job to display the information on by pressing the  $\uparrow$  or  $\downarrow$  key.
2. Press the **Info** softkey. The *Job Info* screen displays the number of records in the job and when it was created.

JobMgr:			
* TOPO11	07-01-20		
@ MQ	07-01-25		
STOUT	07-01-25		
SURVEY	07-01-25		📄
New	Del	Ctrl	Info

Job Info
Job: STOUT
Rec: 1
Creat: 2007-01-25
📄

# Coordinate Geometry (COGO) calculations

From the main menu, press **[2]** to open the *Cogo* menu, or access this menu from any observation or PT input screen.

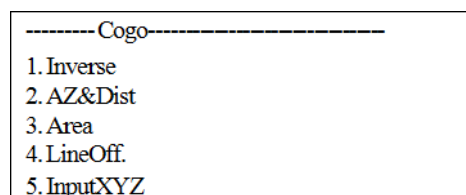

## Inverse calculating

### Inverse PT-PT

PT-PT calculates the distance and the angle between two input points.

- From the *Inverse* menu, press **[1]** (or press **[v]** and **[REC/ENT]**) to select *PT-PT*.

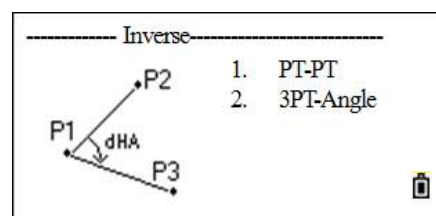

The *Input P1* screen appears.

- Enter the name of P1. Press **[REC/ENT]**.
  - If the points exist in the job, the coordinates are displayed automatically.
  - If the point does not exist in the job, a prompt to enter the coordinates in the coordinate input screen appears. The point is recorded when you press **[REC/ENT]** in the CD field.
  - If **[REC/ENT]** is pressed without entering a point name, a coordinate input screen appears and coordinates can be entered. These coordinates are temporary and are not stored in the database.
  - Press **MSR1** or **MSR2** to measure a point as the first point of the line.
  - Press **LIST** and select the point. To select the point, press **[v]** or **[^]** and then press **[REC/ENT]**. If **[v]** or **[^]** appears in the list screen, press **[>]** or **[<]** to turn the page.
  - Press **STAC** to call up the point.

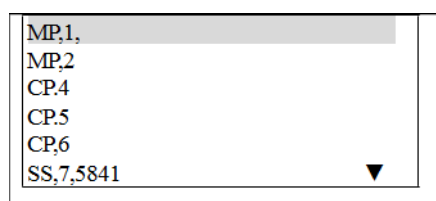
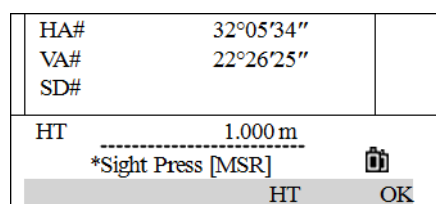
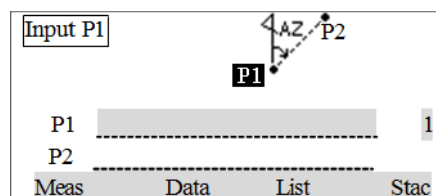



3. Enter the name of P2.

The azimuth, horizontal distance, and vertical distance from the first point to the second point are displayed. Press **DSP** to switch between the two pages.

4. To:
  - Continue in PT-PT, press **NEXT**.
  - Quit, press **END**.
  - To change the contents of the result screen, press **DSP**.

Gd      Grade (HD/VD)  
 V%     100/Gd  
 rSD    Slope distance PT1 to PT2

### 3PT angle

The 3PT angle calculates the angle between two lines defined by three points. PT1 is the base point. Two lines must be defined by P2 and P3, both from P1.

1. From the *Inverse* menu, press **2** (or press **v** and **REC/ENT**) to select *3PT-Angle*.

The *Inp basePT* screen appears.

2. Enter the name of base point P1 and press **REC/ENT**.  
 For the input method, see Step 2 of the Inverse PT-PT method on page 104.
3. Enter the second point (P2) to define the baseline (P1-P2) and press **REC/ENT**.
4. Enter the third point (P3) to define the second line (P1-P3) and press **REC/ENT**.

5. The result of the 3PT angle appears. Press **DSP** to switch between the two pages.

3PT- Angle		1/2
AZ	45°00'00"	
HD1	2.000 m	
HD2	2.828 m	
End		Dsp Next

6. To:
- Continue in 3 Pt. Angle function, press **NEXT**.
  - Quit, press **END**. The screen returns to the *Inverse* menu.

3PT Ang.		2/2
HD3	2.000 m	
*HD1=P1-P2 HD		
HD2=P1-P3 HD		
HD3=P2-P3 HD		
End		Dsp Next

## Azimuth and Distance (AZ&Dist)

Use an angle and distance to calculate a coordinate.

There are two ways to calculate new points using the AZ&Dist function.

### AZ+HD

1. From the *Cogo* menu, press **2** (or press **v** and **REC/ENT**) to select *AZ&Dist*.

The *AZ&Dist* menu appears.

2. Press **1** (or press **v** and **REC/ENT**) to select *AZ+HD*.

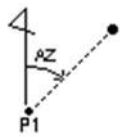
AZ&Dist	
	1. AZ+HD 2. Store
End	

The *Input PT* screen appears.

3. Enter a point name for the base PT and then press **REC/ENT**.

For the input method, see Step 2 of the Inverse PT-PT method on page 104.

Input PT	
	1
PT	_____
Meas Data List Stac	

The *Input AZ* screen appears.

4. Enter the azimuth (AZ), horizontal distance (HD), and vertical distance (dVD) and then press **REC/ENT**.

**Note** – To enter 123°45'45", type 123.4545 and press **REC/ENT**. If a value is not entered in the dVD field, the value 0.000 is used.

Input AZ	
AZ	_____
HD	_____
dVD	_____
End	

A recording point screen with the calculated coordinates appears. PT defaults to the last recorded PT + 1.

5. Enter the code (CD) and then press **[REC/ENT]** to store the point.

N	3.879 m
E	2.684 m
Z	4.000 m
PT	2
CD	
	List Stac

## Store

The store function calculates a new point based on two defined points and angle, horizontal, and vertical distances from the line defined by those two points.

1. From the *AZ&Dist* menu, press **[2]** (or press **[v]** and **[REC/ENT]**) to select *Store*.

— AZ&Dist —	
	1. AZ+HD 2. Store
	Stac

The *Input P1* screen appears.

2. Enter the point name P1 and then press **[REC/ENT]**.  
For the input method, see Step 2 of the Inverse PT-PT method on page 104.

Input P1	
	1
P1	
P2	
Meas	Data List Stac

The *Input P2* screen appears.

3. Enter P2 and then press **[REC/ENT]**.

Input P2	
	1
P1	1
P2	
Meas	Data List Stac

The *Input+AZ* screen appears.

4. Enter the plus-minus angle, horizontal distance (HD), and vertical distance (dVD) from the baseline defined by P1-P2. If you do not enter a value in the dVD field, the value 0.0000 is used.
5. When **[REC/ENT]** is pressed in the dVD field, a new point is calculated. The PT name defaults to the last recorded PT + 1. Press **[REC/ENT]** to record the point.
6. The screen returns to the point input screen. P1 (base PT) defaults to the previously recorded PT. P2 defaults to the previous P1.

Input+AZ	
+AZ	
HD	
dVD	
	Stac

N	0.845 m
E	1.813 m
Z	2.000 m
PT	9
CD	
	List Stac

7. Enter the plus-minus angle, horizontal distance, and vertical distance from the baseline defined by P1-P2, and then press [REC/ENT].
8. A new point is calculated. The PT name defaults to the last recorded PT + 1. Press [REC/ENT] to record the new point.
9. The screen returns to the point input screen. P1 (base PT) defaults to the previously recorded PT. P2 defaults to the previous P1. This function continues like this. Press [ESC] to quit.

N	1.826 m
E	2.719 m
Z	2.000 m

PT 10

CD [ ] Stac

List

**Tip** – To continuously calculate a new point, enter +Ang, HD, and dVD from the previous azimuth line. This is a convenient way to enter Store points.

## Calculate area

1. From the *Cogo* menu, press [3] (or press [v] and [REC/ENT]) to select *Area*.

	<ol style="list-style-type: none"> <li>1. Inverse</li> <li>2. AZ&amp;Dist</li> <li>3. <b>Area</b></li> <li>4. LineOff</li> <li>5. InputXYZ</li> </ol>
--	---

The *Points* screen appears.

2. Enter the first point and then press [REC/ENT].  
 In the upper right corner of the screen, a counter indicates how many points you have entered.  
 For the input method, see Step 2 of the Inverse PT-PT method on page 104.
3. Continue to enter points until all the points in the figure have been defined.

Points	000	1
PT	[ ]	
	* Press [MEMU] View	Stac
Meas	List	

**Note** – The first and last points that have been entered are joined to close the area. The points must be entered in the order in which they define the figure.

Points	003	1
PT	[ ]	
	* Press [MEMU] View	Stac
Meas	Calc	List

4. To calculate the area and perimeter, press *Calc*.
  - To switch the Area units, press *Unit*.
  - To add points to the figure, press *Next*.
  - To record the area calculation results, press *Rec*.

Area:	64.000 m <sup>2</sup>
Perimeter:	32.000 m

Unit Next Rec

## Line and offset

To calculate coordinates using Line and Offset:

1. From the *Cogo* menu, press **4** (or press **v** and **REC/ENT**) to select *LineOff*.

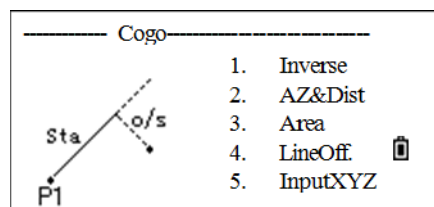

The *Input P1* screen appears.

2. Enter the base point (P1).

For the input method, see Step 2 of the Inverse PT-PT method on page 104.

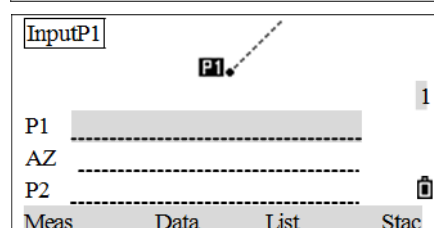

3. Enter the AZ angle. A value can be entered in either the AZ or P2 field to specify the azimuth P1-P2.

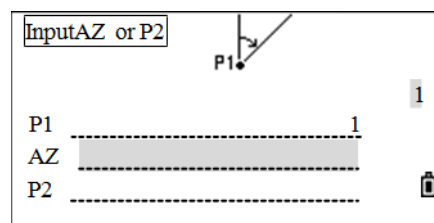

4. Enter the horizontal distance along the baseline (STA).
5. Enter the horizontal distance perpendicular to the line (O/S).

**Note** – A negative value in the *STA* field means the opposite direction along the defined azimuth line. A negative value in the *O/S* field is for the left side of the azimuth line.

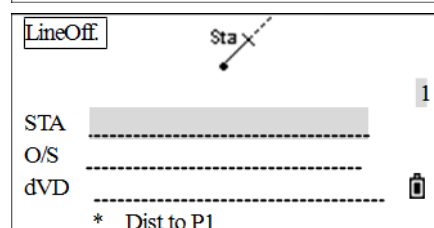

6. Enter the vertical distance (dVD).
7. To calculate the coordinates of the point, press **REC/ENT** in the dVD field. The Z coordinate can be changed here.
8. To record the point, press **REC/ENT** in the CD field.

The coordinates are stored as a CC (calculated coordinates) record. Line definition information and STA, O/S, and dVD values are stored in comment (CO) records.

## Entering coordinates manually

1. From the *Cogo* menu, press **5** (or press **v** and **REC/ENT**) to select *InputXYZ*.

A point input screen appears.

2. Enter the coordinates using the numeric keys. To move to the next field, press **REC/ENT** or **v** in a field.

3. Press **REC/ENT** in the Z field to save the point as a manually input record. The display returns to the point input screen. The default PT is incremented to the next value.

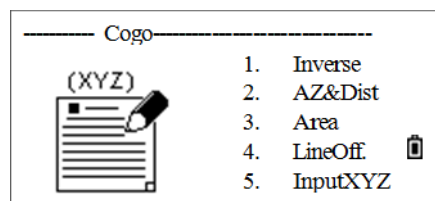

## Settings

See also Job settings, page 102.

1. From the main menu, press **3** (or press **v** + **REC/ENT**) to select *Set*.

The *Settings* menu appears.

2. Press **v** / **v** + **REC/ENT** or the numeric key to select the item for which settings are to be made. This procedure uses the Angle setting as an example.

3. To open the *Angle* menu, press **1**.

4. Press **v** / **v** to move to items that need to be changed.

5. Press **▷** / **◁** to change the settings, and then press **REC/ENT**.

6. If any of these settings are changed while a job is open, a confirmation screen appears prompting for the current job to be closed. Press **ABRT** to use the settings in the current job and cancel the change. Press **OK** to close the job. Then, in the measure or record function, the program will prompt you to select or create a job.

The display returns to the *Settings* menu.

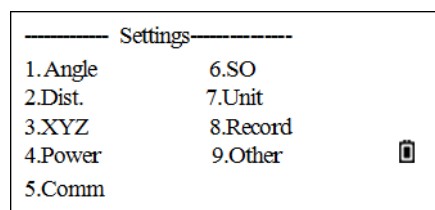

In the following list, items shown in ***bold italics*** cannot be changed once a job is created.

Item	Options
Angle	<b><i>VA0</i></b> : Zenith, Vertical, Vert ±90 <i>Min</i> : Ang 1", 5", 10"
	<b><i>HA</i></b> : Azimuth, 0 to BS When this field is set to Azimuth, the horizontal angle (HA) that is displayed and recorded is an Azimuth value. When this field is set to 0 to BS, HA is in HA zero to BS value.

Item	Options
Dist.	<b>Scale:</b> Numeric value between 0.990000 and 1.010000
	<b>T-P crn:</b> ON, OFF
	<b>SeaLevel:</b> ON, OFF
	<b>C&amp;R crn:</b> OFF, 0.14, 0.200
	<b>Max Dist:</b> 2000 m, 5000 m Select max range of laser distance measurement, only for reflectorless total station.
XYZ	<b>Order:</b> NEZ, ENZ
	<b>Marker:</b> NEZ, XYZ, YXZ
	<b>AZ 0:</b> North, South
Power	<b>Power off:</b> 5 min, 10 min, 30 min, OFF
	<b>EDM off:</b> Now, 0.1 min, 0.5 min, 3 min, 10 min, OFF
	<b>Sleep:</b> 1 min, 3 min, 5 min, OFF
	<b>Mode:</b> Spectra Prec, Setting
	<b>Baud:</b> 1200, 2400, 4800, 9600, 19200, 38400, 57600, 115200
Comm	<b>DataL:</b> 8, 7
	<b>Parity:</b> None, Even, Odd
	<b>Stop:</b> 1, 2
SO	<b>Add PT:</b> This field sets the default point number to record observed data in stakeout.
Unit	<b>Angle:</b> DEG, GON, MIL
	<b>Dist:</b> Meter, USA Feet, USA Inch, IntlFeet, IntlInch
	<b>Temp:</b> °C, °F
	<b>Press:</b> hPa, mmHg, inHg
Record	<b>Store DB:</b> RAW+XYZ, RAW, XYZ This setting determines whether raw and/or coordinate data is stored when recording SS, CP, or SO records in the Basic Measurement screen or Stakeout screen.
	<b>REC Data:</b> MEM, COMM Set this item to COM to output data on the COM port. The data is not stored to the job file.
Other	<b>XYZ Dsp:</b> Quick, Normal, Slow, Enter. Defines the speed to move to the next screen after showing XYZ of the input PT.
	<b>2nd Unit:</b> Meter, USA Feet, USA Inch, IntlFeet, IntlInch, None.
	<b>Beep:</b> ON, OFF
	<b>Split ST:</b> ON, OFF The point numbers of station points can be separated from other record type point numbers. If Split ST is set to ON, a single ST number can be entered in an additional setting screen. Or <b>[REC/ENT]</b> can be pressed to use the default point name
	<b>InputCod:</b> ALPH, NUM <b>User Information:</b> Enter owner information up to 20 characters.

# Data

Data can be viewed at any time, even in an observation screen or while entering points.

## RAW data

### Viewing raw data

1. From the main menu, press **[4]** (or press **[v]** and **[REC/ENT]**) to select *Data*.

The *View/Edit* menu appears.

2. Press **[1]** to select *Raw Data*.

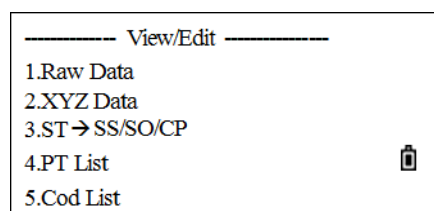

3. The raw data records display in a list. The cursor remains on the last raw data record in the current job. Press **[^]** or **[v]** to scroll through and select a record.

- CP records are shots taken in the *Angle* or *Repeat* menus, or in the Basic Measurement screen.
- F1 and F2 records are Face-1 and Face-2 measurements.
- SS records are sideshots (topo shots). All shots from the Basic Measurement screen are stored as SS records.

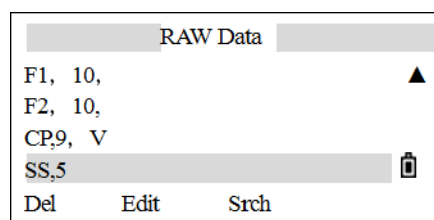

To view detailed information for the selected records, press **[REC/ENT]**.

4. To return to the record list, press **[ESC]**.

**Note** – Raw records contain *PT, HT, CD, and HA/VA/SD*.

When the Store DB setting is set to RAW+XYZ, press **[DSP]** to switch between the screens.

When more than one measurement is taken to the same point and to overwrite the XYZ data is selected, the old raw record becomes raw data only. As a result, only one SS(RAW) record keeps its corresponding SS(XYZ) record. Other SS(RAW) records to the same point no longer have coordinates available.



### ST (station) records

ST (station) records contain ST, HI, BS, and AZ fields.

Press **[DSP]** to view XYZ coordinates.

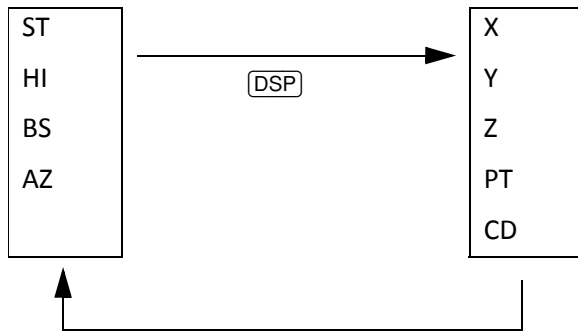

When a new ST point name is assigned in `Stn Setup > QuickStn`, the coordinates of the station are recorded as (0, 0, 0).

### SO (stakeout) records

This is data recorded in stakeout functions.

Press **[DSP]** to switch between the screens.

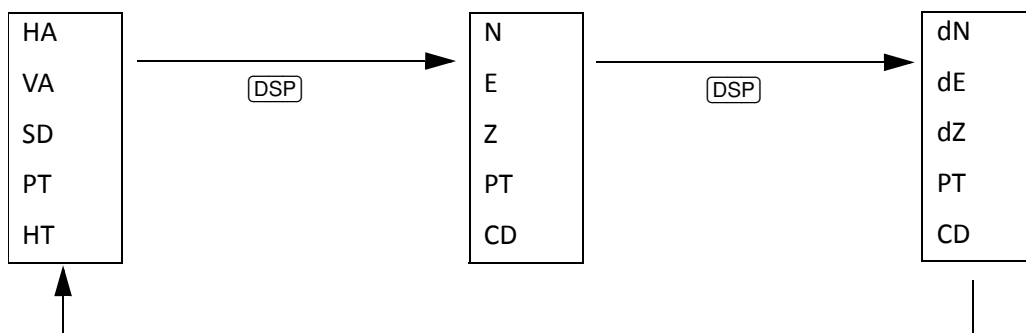

dN/dE/dZ store the difference between the stakeout point's actual position and its designed position.

### CO (comment) records

A CO record is a comment added to the job from the system.

For example, when the Stn-Z is changed using the Z-Coord function, or the horizontal angle is reset using the BSCheck function, the system writes a comment record. This screen shows an example of a comment in the Z-Coord function.

CO,Remote BM Calc.Z=3.471 -Stn Point Updated	
Del	

When a Stn-XYZ is input by Base-XYZ function, the recorded station appears as a comment record.

This screen shows a record of temperature, pressure, and prism constant that is saved when the station setup is completed.

CO,Temp 26.0°C Press 1023.0 hPa Prism -30mm 2007.02.03 11 19 00	
Del	

### Deleting raw records

1. In the *RAW* screen (or in the data screen that appears when you press **REC/ENT**), press **^** or **v** to highlight the record to be deleted.
2. Press the **DEL** softkey.  
A confirmation screen appears.
3. To delete the selected record, press **REC/ENT** or the **OK** softkey. (Otherwise, press the **CE** softkey.)  
The system returns to the *RAW* data screen.

### Editing raw records

1. In the *RAW* screen (or in the data screen that appears when you press **REC/ENT**), press **^** or **v** to highlight the record that you want to edit.
2. Press the **Edit** softkey.
3. Enter the new data manually or select data using the **List** or **Stac** softkey and then press **REC/ENT**.
4. To rewrite the data, press **REC/ENT** or the **OK** softkey. (Otherwise, press the **CE** softkey.)  
The system executes the selected operation and returns to the *RAW* screen.

## Searching raw records

1. In the *RAW* screen, press the **SEARCH** softkey.
2. Enter the search criteria by doing one of the following:
  - To find a point by name, enter the name in the PT field and press **REC/ENT** twice.
  - Use the asterisk (\*) as a wildcard. For example, when **30\*** is entered in the PT field, the search matches the points named 300, 301, 302, 3000A2, and 3010.
  - To search by point type, press **V** to move to the Type field and press **<** or **>** to change the selected point type. The options are ALL, ST, SS, SO, CP, CO, and MLM.

**Note** – If a type in the Type field is selected, a value in the CD field does not have to be entered. Press **REC/ENT** in the PT field to start the search.

3. If more than one point matches the search criteria, the matching points are displayed in a list. Press **^** or **v** to highlight the point to be used. Then press **REC/ENT** to select it.
4. Detailed data for the selected record appears. Press the **DISP** softkey to change the fields shown. Press **ESC** to return to the list.

**Note** – If no point matches the specified criteria, an error screen appears. Press any key to return to the data screen.

## Coordinate data

### Viewing coordinate data

1. From the *View/Edit* menu, press **2** (or press **V**) and **REC/ENT** to select *XYZ Data*.

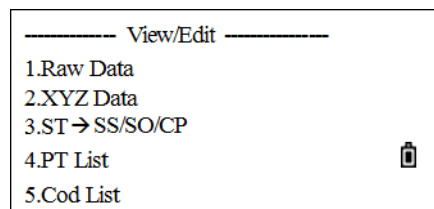

The *XYZ Data* screen appears.

**Note** – The header (*XYZ, YXZ, NEZ, or ENZ*) depends on the *Coord. Label setting*.

2. Coordinate data appears in a list, with the newest record at the bottom of the screen—the cursor stays on the last coordinate record of the current job. Press **^** or **V** to scroll through the records. Press **←** or **→** to move up or down one page.
3. Once a record has been selected, press **REC/ENT** to see more detailed information about it.
4. Press **ESC** to return to the list.

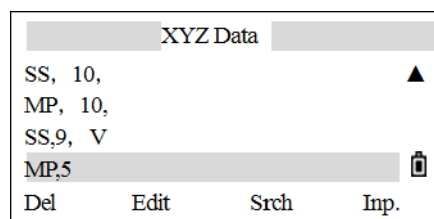

The following record types are available:

- UP records are uploaded point coordinates
- MP records are manually input point coordinates
- CC records are points calculated in Cogo
- RE records are points calculated in Resection.
- SS records are sideshots. All shots made from the Basic Measurement screen are stored as SS records.

When the Store DB data setting is set to RAW+XYZ or to XYZ, points in the Basic Measurement screen (SS records), in various O/S functions (SS records), in 2Pt.Ref. L and Ref.Arc in PRG (SS records) and in some Stakeout functions (SO records) store coordinate records as well. The format of the data is the same as other coordinate records.

All coordinate records contain PT, CD, N, E, and Z fields.

### Deleting coordinate records

1. In the *XYZ Data* screen (or in the data screen that appears when **REC/ENT** is pressed), press **^** or **V** to highlight the record to be deleted.
2. Press the **DEL** softkey.
3. To delete the selected record, press **REC/ENT** or the **OK** softkey. (Otherwise, press the **CE** softkey.)

The data is deleted and the *XYZ Data* screen appears.

## Editing coordinate records

PT, CD, and coordinate data can be edited.

**Note** – The coordinate record for the current station or the coordinate record from measurement (the SS record) cannot be edited.

1. In the XYZ Data screen (or in the data screen that appears when you press **REC/ENT**), press **▲** or **▼** to highlight the record to be edited and then press the **Edit** softkey.
2. Enter the new data manually and then press **REC/ENT** in the CD field.  
A confirmation screen appears.
3. To accept the changes and return to the data view screen, press **REC/ENT** or the **OK** softkey. (Otherwise, press the **CE** softkey.)

## Searching coordinate records

1. In the XYZ Data screen, press the **SEARCH** softkey to access the XYZ data search function.
2. Enter the search criteria:
  - To find a coordinate by name, enter the name in the PT field and press **REC/ENT** twice.
  - The asterisk (\*) can be used as a wildcard in the PT or CD field. For example, when 500\* is entered in the PT field, the search matches the points named 500, 500-1, 500-A, and 5000.
  - To search by point type, move to the Type field and press **<** or **>** to change the selected point type. The options are ALL, MP, UP, CC, and RE.
3. If more than one point matches the search criteria, the matching points are displayed in a list. Press **▲** or **▼** to highlight the point to be used. Press **REC/ENT** to select it.
4. Detailed data for the selected record appears. Press **ESC** to return to the list.

**Note** – If no point matches the specified criteria, an error screen appears. Press any key to return to the data screen.

## Entering coordinates

1. In the XYZ Data screen, press the **INF** softkey to display a new input point screen.  
The PT field defaults to the last recorded PT + 1, but the value shown can be changed.
2. Enter the coordinates and the PT and CD and then press **REC/ENT**. When you press **REC/ENT** in the CD field, the point is stored as an MP record.
3. After the point is recorded, the next point input screen is shown with the updated default PT. NE, NEZ, or Z-only data can be recorded to the database.

## Station records

### Viewing records by station

1. From the *Data* menu, press **3** (or press **v** and **REC/ENT**) to select *ST* → *SS/SO/CP*.

The *Stn Data* screen appears.

2. Press **^** or **v** to scroll through the list.
3. To view detailed information about the selected station, press **REC/ENT**. Press **ESC** to return to the list.
4. To display all the observation data from the selected station, press **REC/ENT** again.

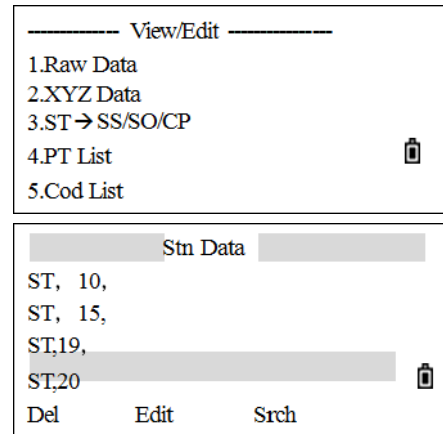

**Note** – Detailed data is as for raw data. For detailed information about each point type and format, see *RAW* data, page 112.

### Deleting station records

1. In the *Stn Data* screen (or in the data screen that appears when you press **REC/ENT**), press **^** or **v** to highlight the record to be deleted. Then press the **DEL** softkey.
2. A confirmation screen appears. Press **REC/ENT** or the **OK** softkey to delete the selected record. (Otherwise, press the **CE** softkey.)
3. A reconfirmation screen appears. Press the **OK** softkey to delete the selected record. (Otherwise, press the **CE** softkey.)

### Editing station records

The system will not recalculate measurements if the station record is changed—this means that the current station cannot be edited.

1. In the *Stn Data* screen (or in the data screen that appears when **REC/ENT** is pressed), press **^** or **v** to highlight the record to be edited. Then press the **Edit** softkey.
2. Enter the new data manually or select data using the **List** or **Stac** softkey and then press **REC/ENT**.
3. To rewrite the data, press **REC/ENT** or the **OK** softkey. (Otherwise, press the **CE** softkey.)

The system executes the operation and returns to the *RAW Data* screen.

**Note** – If the station (*ST*) or instrument height (*HI*) values are changed, the coordinates of observation points are not recalculated. If the *BS* or *AZ* values are changed, raw records are not recalculated.

## Searching station records

1. In the *Stn Data* screen, press the **Search** softkey.
2. Enter the search criteria:
  - To find a point by name, enter the name in the PT field and press **REC/ENT** twice.
  - The asterisk (\*) can be used as a wildcard in the PT or CD field. For example, when you enter **500\*** in the PT field, the search matches the points named 500, 500-1, 500-A, and 5000.
3. If more than one point matches the search criteria, the matching points are displayed in a list. Press **^** or **v** to highlight the point to be used. Press **REC/ENT** to select it.
4. Detailed data for the selected record appears. Press **ESC** to return to the list.

**Note** – If no point matches the specified criteria, an error screen appears. Press any key to return to the data screen.

## Point name list and code list

The instrument stores two list files: a list of PT names and a list of CD names. The structure and functionality of these files is the same; that is, delete, edit, add points/codes, and layers can all be applied using the softkeys.

- The *PT name list* is useful if more than one pattern of point names is to be used in the field. For example, it may be needed to use points named PT=1, 2, 3 ..., as well as points named PT=C1, C2, C3 ....
- The *code list* is a list of feature codes. It can be used to store custom codes.

The point or code names and layers are shown in alphabetic order. Use the softkeys to customize the list.

A maximum of 256 points can be stored.

## Deleting points, codes, or layers

1. From the *Data* menu, do one of the following:
  - Press **4** (or press **v** and **REC/ENT**) to select *PT List*. The point list appears.
  - Press **5** (or press **v** and **REC/ENT**) to select *Code list*. The code list appears.
2. In the point or code list, press **^** or **v** to highlight the item to be deleted. Then press the **DEL** softkey.
3. A confirmation screen appears. Press **REC/ENT** or the **OK** softkey to delete the item. (Otherwise, press the **CE** softkey).

## Editing an item in the point list or code list

- From the *Data* menu, do one of the following:
  - Press **4** (or press **v** and **REC/ENT**) to select *PT List*. The point list appears.
  - Press **5** (or press **v** and **REC/ENT**) to select *Code list*. The code list appears.
- In the point or code list, press **^** or **v** to highlight the item to be deleted and then press the **Edit** softkey.
- A confirmation screen appears. Press **REC/ENT** or the **OK** softkey to accept the changes and update the list. (Otherwise, press the **CE** softkey).

## Adding a point name

- From the *Data* menu, press **4** (or press **v** and **REC/ENT**) to select *PT List*.

The *Point name* screen appears.

- Press the **Add** softkey.
- Enter the PT name and then press **REC/ENT**.

The added point appears in the list.

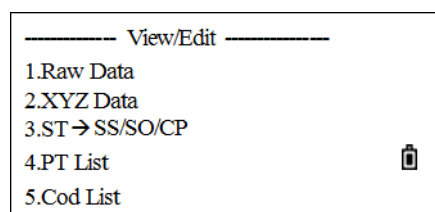

## Adding a code

- From the *Data* menu, press **5** (or press **v** and **REC/ENT**) to select *Cod list*.

The code list appears.

- Press the **Add** softkey.
- Enter the serial number in the CD field and then enter code content in the Rec field. If the Rec field is left blank, the CD value is stored. When the entry is completed, press **REC/ENT**.

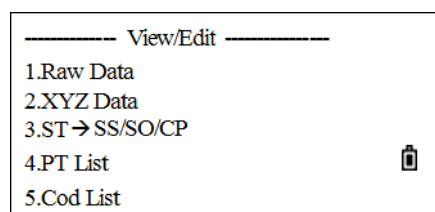

The added code appears in the list. A maximum of 256 codes can be stored.

**Note** – The *Rec. field* is optional. When a corresponding code for every serial number is needed, the code content can be entered in this field. For example, if **12** is entered in the CD field, and **FENCE** in the Rec field, it means enter **FENCE** as a code, with the serial number **12**. In Quick Code function, the serial number (CD) can be entered to call up the code.

**Note** – To save the code to be the same as the one in the CD field, leave the Rec field blank and press **REC/ENT**.



# Communication

## Downloading data from the total station to a computer

**Note** – This procedure describes downloading data using a cable—the instrument also supports mini USB port and SD card. The cable driver must be installed if a multi-port cable (integrated RS-232 and mini USB) is used.

1. Use the communication cable to connect the instrument to a computer. If required, install the driver of the cable.
2. On the computer, start the data transfer software and then select *COM / Param Setting*:

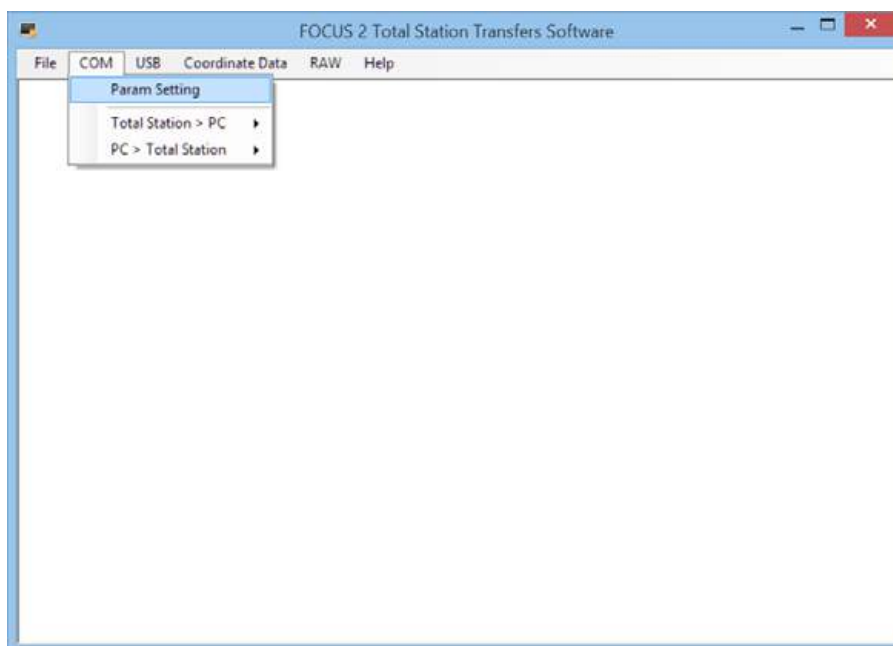

3. Ensure that the communication settings match the settings on the total station. If required, make any changes and then click **OK**:

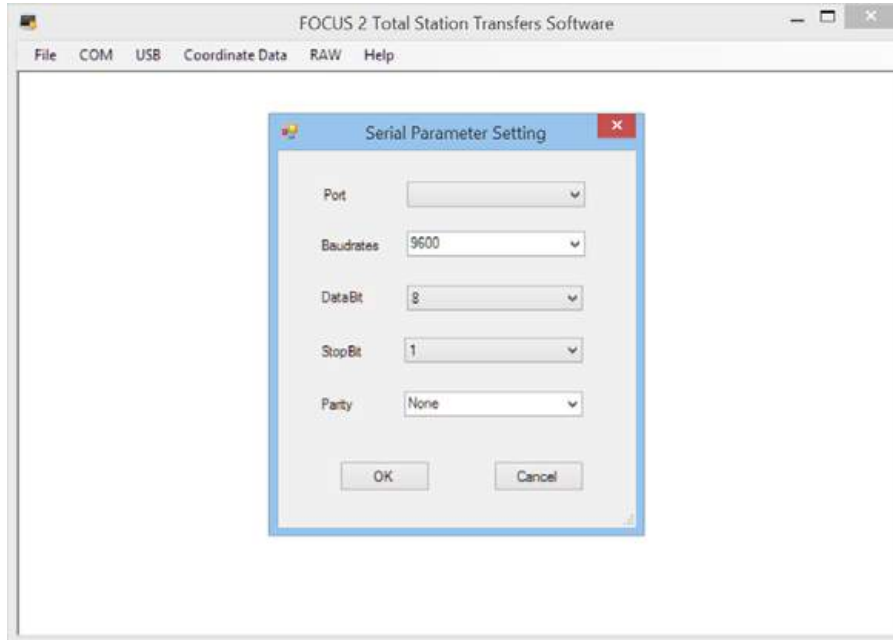

4. Select *COM / Total Station > PC*:

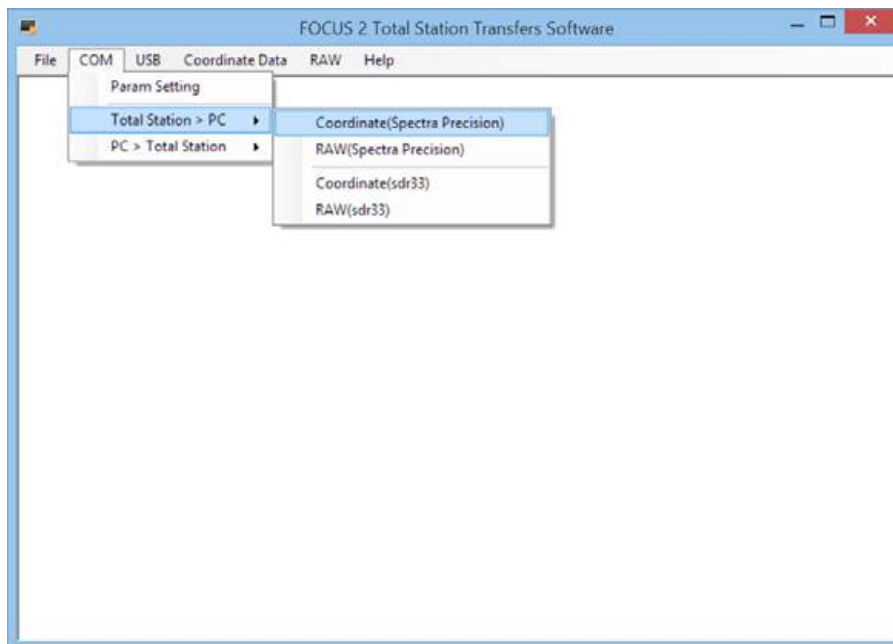

5. The system prompts for confirmation before starting the transfer. **Before clicking OK, first complete Step 5 through Step 12 on the total station.**

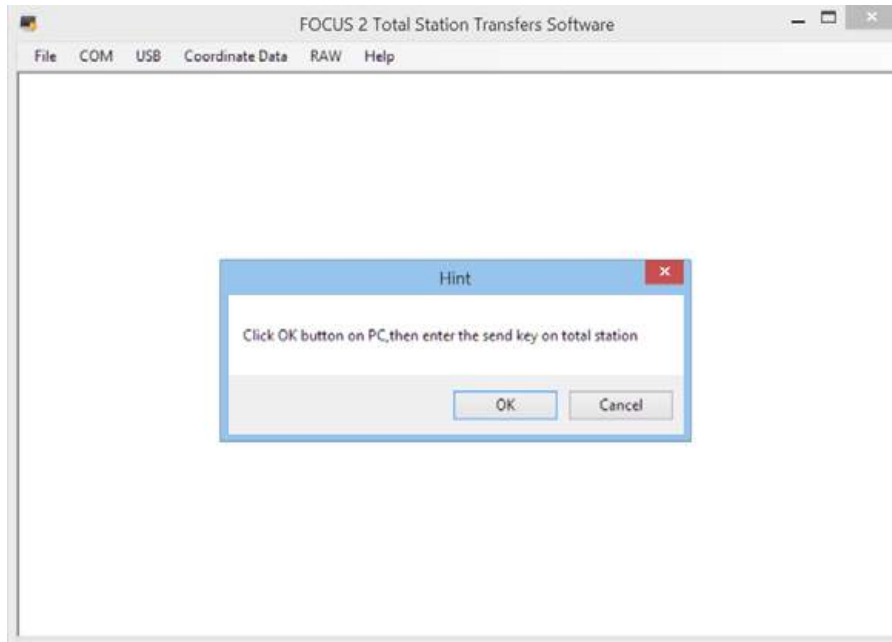

6. On the total station, in the main menu, press **[5]** or scroll down to Comm.

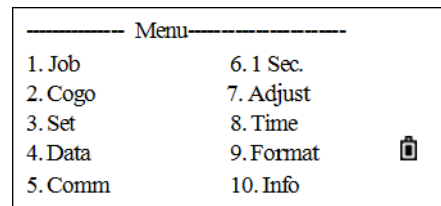

The *Communication* menu appears.

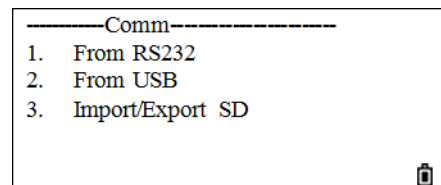

7. Press **[1]** to select *From RS232* to transfer data using the RS-232 cable.
8. Press **[1]** to select SendData.
9. Press the **JOB** softkey and then press **[v]/[^]** to select the jobs from which the data is going to be downloaded. Press **[REC/ENT]** to return.

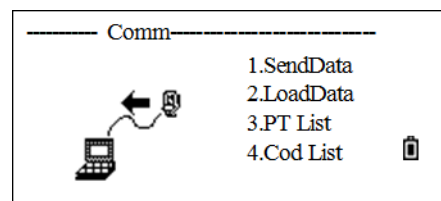

10. To set the communication parameters, press the **COMM** softkey.
- To select an item, press **[v]/[^]**.
  - To select an option, press **[<]/[>]**. Press **[REC/ENT]** to return after setting the parameters.

11. Set the format of the data. Press  $\leftarrow/\rightarrow$  and then press  $\boxed{\text{REC/ENT}}$  to confirm. The data format options are Spectra / SDR33.
12. To select the format of the data that being transferred, press  $\leftarrow/\rightarrow$  and then press  $\boxed{\text{REC/ENT}}$  to confirm. The types of transferred data are RAW Data/XYZ Data.
13. On the computer, click **OK**.
14. On the instrument, press the  $\text{Start}$  softkey.
15. To stop the transfer, press  $\text{STOP}$  softkey. Once the transfer is complete, the *Comm* menu appears.

## Uploading coordinate data

1. Use the communication cable to connect the instrument to a computer, and ensure the communication settings match the settings in the total station.
2. Select *File / Open* and select the file to upload to the total station. This file can be one generated by the software or it can be a text file:

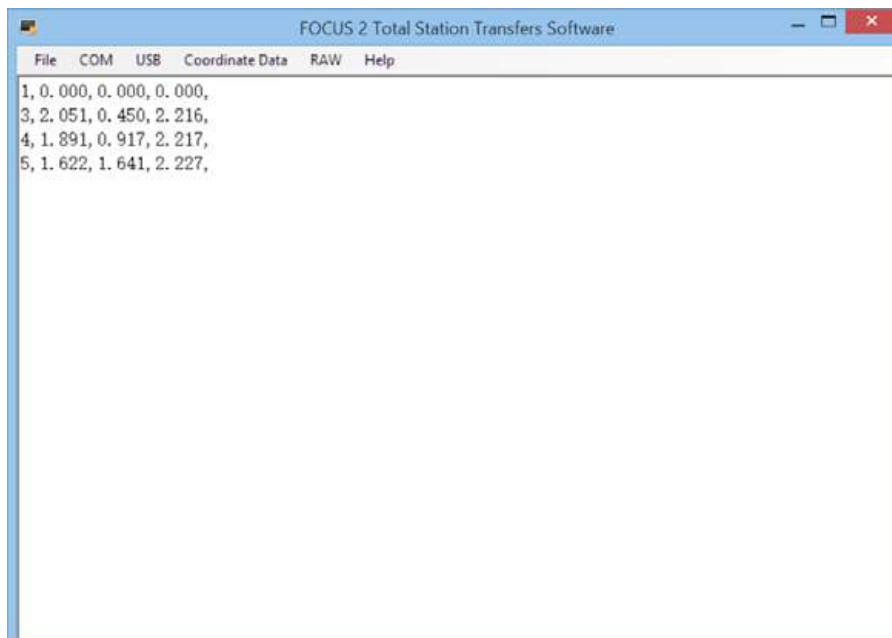
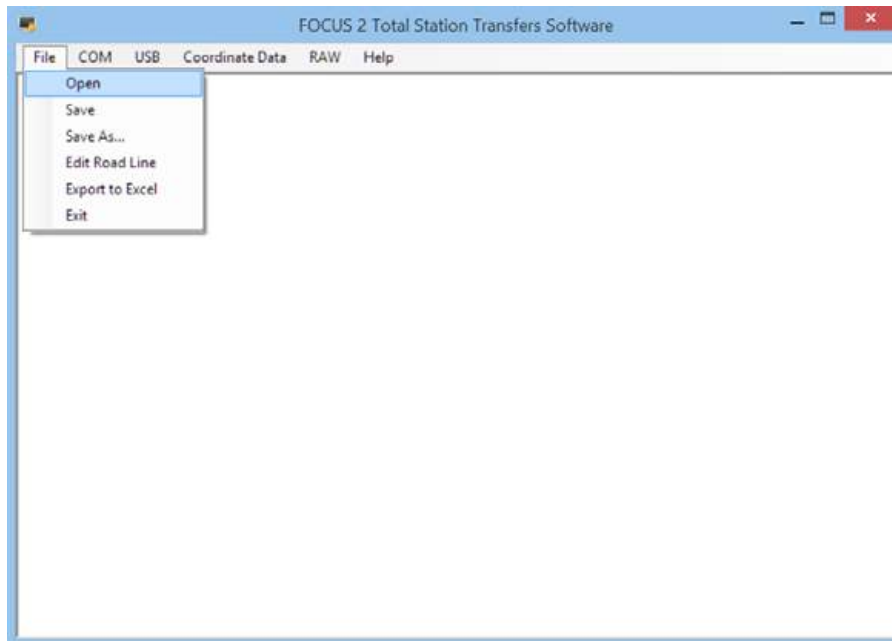

3. Select *COM / PC > Total Station*:

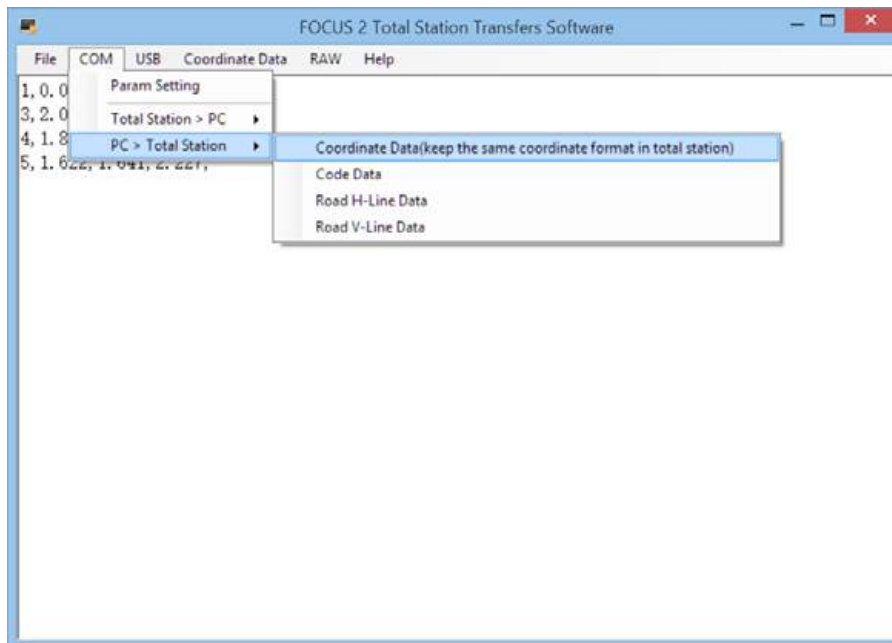

4. The system prompts for confirmation before starting the transfer. **Before clicking OK, first complete Step 5 through Step 11 on the total station.**

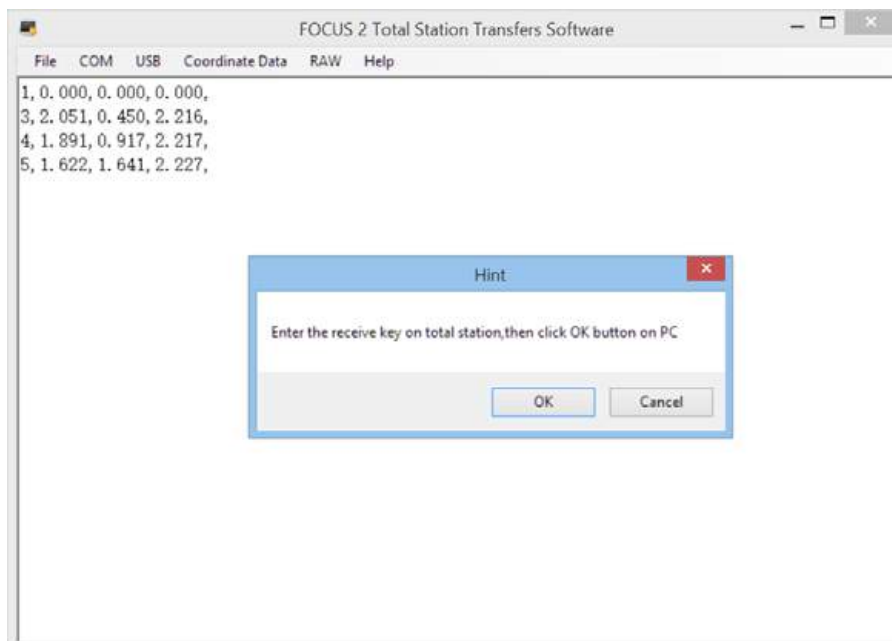

5. On the total station, from the main menu, press **[5]** or scroll down to select *Comm.*  
 6. In the *Communication* menu, press **[2]** (press **[v]** and **[REC/ENT]**) to select *Load Data.*

7. Press the **Job** softkey and then press  $\boxed{v}$  /  $\boxed{\wedge}$  to select the job in which to load the data. Press  $\boxed{\text{REC/ENT}}$  to return.
8. To set the communication parameters, press the **Comm** softkey.
  - To change any items so that they match the settings in the communication software, press  $\boxed{v}$  /  $\boxed{\wedge}$ .
  - To change the item options, press  $\boxed{\leftarrow}$  /  $\boxed{\rightarrow}$ . Press  $\boxed{\text{REC/ENT}}$  to return.
9. The default data format appears. To change the order of the data fields, press the **Edit** softkey. Press  $\boxed{\leftarrow}$  /  $\boxed{\rightarrow}$  to select a job and then press  $\boxed{\text{REC/ENT}}$  or the **Save** softkey.
10. Once the settings have been completed on the instrument, press the **Start** softkey.
11. On the computer, click **OK**.
12. To stop the transfer, press the **Stop** softkey on the instrument. Once the transfer is complete, the *Comm* menu appears.

## Uploading a point name list or code list

1. Use the communication cable to connect the instrument to a computer, and then start the communication software.
2. Select *COM / PC > Total Station*. Navigate to and select the PT List file to upload.
3. The system prompts for confirmation before starting the transfer. **Before clicking OK, first complete Step 5 through Step 7 on the total station.**
4. On the total station, in the main menu, press  $\boxed{5}$  (or press  $\boxed{v}$  and  $\boxed{\text{REC/ENT}}$ ) to select *Comm*. The *Comm* menu appears.
5. Press  $\boxed{3}$  (or press  $\boxed{v}$  and  $\boxed{\text{REC/ENT}}$ ) to select *PT List*. The *PT List* screen appears.
6. To set the communication parameters, press the **Comm** softkey. Ensure that the total station settings are consistent with those set in the communication software.
7. On the instrument, press the **Start** softkey.
8. On the computer, click **OK**.
9. To stop the transfer, press the **Stop** softkey on the instrument. Once the transfer is complete, the *Comm* menu appears.

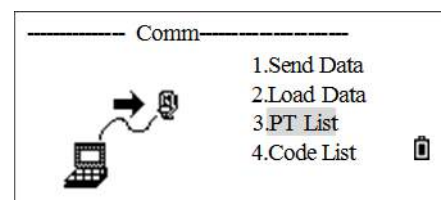

**Note** – When uploading a code list, it always replaces the existing code list on the instrument. A maximum of 256 codes or point names can be stored.

# 1 Sec Keys

Use the *1 Sec Keys* menu to configure the settings for the one-second keys, **[MSR1]**, **[MSR2]**, **[DSP]**, **[USR1]**, **[USR2]**, **[S-O]**, and **[DAT]**. One second keys are functions that can be accessed directly by holding down that specific key for one second.

## **[MSR]** key settings

- From the main menu, press **[6]** (or press **[v]** and **[REC/ENT]**) to select *1 Sec.*

The *1Sec. key* menu appears.

- Press **[1]** to select *[MSR]*.
- There are two **[MSR]** keys on the keyboard; each key has its own settings.
  - To change the settings for the **[MSR1]** key, press **[1]** or select **MSR1**.
  - To change the settings for the **[MSR2]** key, press **[2]** or select **MSR2**.

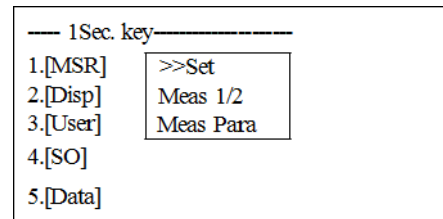

- Each **[MSR]** key has four settings. In the Const field, use the numeric keys to enter values. In the other fields, press **[<]** or **[>]** to change the settings.
- When the settings are complete, press **[REC/ENT]** to return to the *1Sec. key* menu.

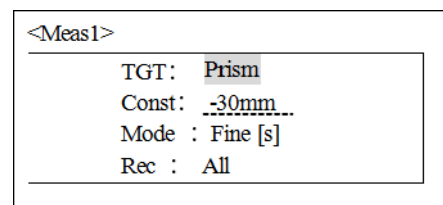

**Tip** – You can also access the settings screen by holding down **[MSR1]** or **[MSR2]** for one second.

## **[DSP]** key settings

- From the main menu, press **[6]** (or press **[v]** and **[REC/ENT]**) to select *1 Sec.*

The *1Sec. key* menu appears.

- Press **[2]** (or press **[v]** and **[REC/ENT]**) to select *[Disp]*.

**Tip** – You can also access the settings screen by holding down **[DSP]** for one second.

- To move the cursor, press **[<]**, **[>]**, **[^]**, or **[v]**. To change the display item, press either the **[↑]** softkey or the **[↓]** softkey.
- To save the changes, press **[REC/ENT]** at the last line of **<DISP3>** or press the **Save** softkey to return to the *1 Sec key* menu.

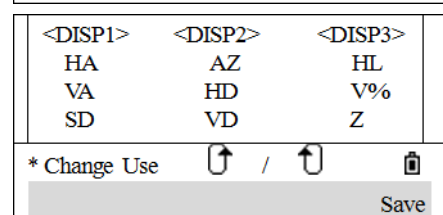
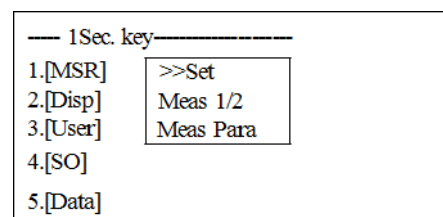



## **USR** key settings

1. From the main menu, press **6** (or press **v** and **REC/ENT**) to select *1 Sec.*

The *1Sec* key menu appears.

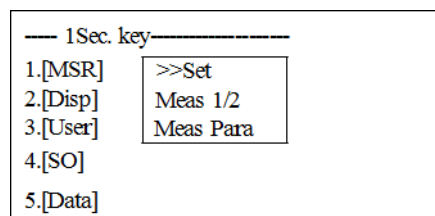

2. Press **3** (or press **v** and **REC/ENT**) to select *[User]*.
3. There are two **USR** keys. The function that is assigned to each key appears beside the key name.
  - To change the settings for the **USR1** key, press **1** or select *User 1*.
  - To change the settings for the **USR2** key, press **2** or select *User 2*.
4. Press **v** or **^** to select the required function and then press **REC/ENT**. If an item on the list has an arrow next to it, and you select this item, the whole menu is assigned to the key. To assign a specific function from the sub-menu, press **^** or **v** to select the function and then press **REC/ENT**.
5. When the settings are complete, press **REC/ENT** to return to the *1 Sec. key* menu.

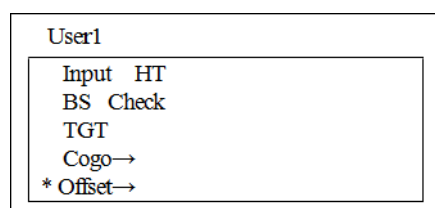
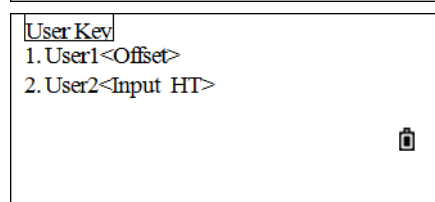

**Note** – In the *Select Functions* screen, the asterisk (\*) indicates the function that is currently assigned to the key.

 **Tip** – You can also access the settings screen by holding down **USR1** or **USR2** for one second.

## **S-O** key settings

1. From the main menu, press **6** (or press **v** and **REC/ENT**) to select *1 Sec.*

The *1Sec* key menu appears.

2. Press **4** (or press **v** and **REC/ENT**) to select *[SO]*.

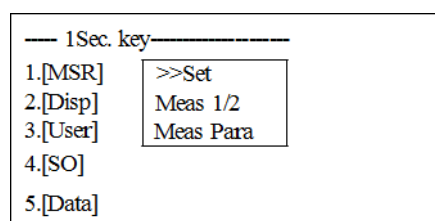

The S-O menu appears.

3. Enter the add constant for the Stakeout point and then press **[REC/ENT]**. The 1Sec key menu appears.

**Note** – If the point to be staked is 103 and the add constant is 1000, the SO point is 1103.

**Tip** – You can also access the settings screen by holding down **[USR1]** or **[USR2]** for one second.

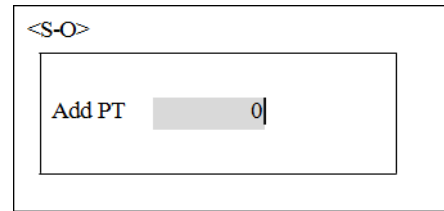

## **[DAT]** key settings

1. From the main menu, press **[6]** (or press **[v]** and **[REC/ENT]**) to select 1 Sec.

The 1Sec. key menu appears.

2. Press **[5]** (or press **[v]** and **[REC/ENT]**) to select [Data].

The asterisk (\*) indicates the currently selected view format.

3. To move the cursor, press **[^]** or **[v]** and then press **[REC/ENT]** to confirm the change.
4. When you press **[Data]** again, the set data type appears.

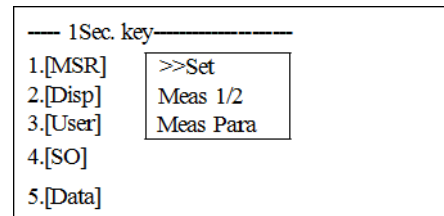

## Date and time

Use the *Date & Time* screen to set the current date and time.

- From the main menu, press **8** (or press **v** and **REC/ENT**) to select *Time*.

----- Menu -----		
1. Job	6. 1 Sec.	
2. Cogo	7. Adjust	
3. Set	8. Time	
4. Data	9. Format	
5. Comm	10. Info	

The current date and time settings are displayed.

- Enter the date in Year-Month-Day format. For example, to change the date to 18 June 2010, press **2** **0** **1** **0** **.** **6** **.** **1** **8** **REC/ENT**.
- To move to the Time field, press **REC/ENT** in the Date field.
- Enter the time in 24-hour format. For example, to set the time to 4:35:06 PM, press **1** **6** **.** **3** **5** **.** **0** **6** **REC/ENT**.
- Do one of the following:
  - To finish setting the date and time, press **REC/ENT** in the Seconds field.
  - To cancel the input, press **ESC**.

<Date>	
Date	<u>2009.05.19</u>
Time	<u>15_25_05</u>
* yy.mm.dd	

## Format

From the main menu, press **9** (or press **v** and **REC/ENT**) to select *Format*.

----- Menu -----		
1. Job	6. 1 Sec.	
2. Cogo	7. Adjust	
3. Set	8. Time	
4. Data	9. Format	
5. Comm	10. Info	

The *Format* menu appears.

The options are:

- Delete All Data: Delete all data in memory, with the jobs and job settings unchanged.
- Delete All Jobs: Delete all files in memory.
- Initialization: Delete all data and files, and return to initial settings.

Format	
1. Delete All Datas	
2. Delete All Job	
3. Initialization	

# Information

From the main menu, press **10** (or press **v** and **REC/ENT**) to select *Info*.

The *Info* screen appears containing the following information:

- The instrument type: FOCUS 2 (2")
- Number: Serial number of the instrument.
- Version: On-board software version.
  - HVer: Version of the angle measurement system
  - SVer: Version of the distance measurement system

Menu	
1. Job	6. 1 Sec.
2. Cogo	7. Adjust
3. Set	8. Time
4. Data	9. Format
5. Comm	10. Info

# Checking and Adjustment

## In this chapter:

- Adjusting the electronic level
- Checking and adjusting the circular level
- Checking and adjusting the optical plummet
- Zero point errors of vertical scale and horizontal angle corrections
- Checking the instrument constant
- Checking the laser pointer

This instrument has undergone a strict process of checking and adjustment to ensure it meets quality requirements. However, after transportation or in changing environments, there may be some adverse effect on the internal structure. Therefore, before the instrument is used for the first time, or before precise surveys, you should use the checking and adjustment procedure introduced in this chapter.

## Adjusting the electronic level

Adjustment of the electronic level is done by Zero point errors of vertical scale and horizontal angle corrections. For detailed instruction, please see page 135.

## Checking and adjusting the circular level

Once you have checked and adjusted the electronic level, check the circular level.

If the bubble is not in the center of the level, use the adjusting pin to rotate the three adjustment screws of either circular level on the instrument main body or tribrach until the bubble is centered.

## Checking and adjusting the optical plummet

The optical axis of the plummet must be aligned with the vertical axis of the instrument.

To check and adjust the optical plummet:

1. Place the instrument on the tripod. You do not have to level the instrument.
2. Place a thick sheet of paper marked with an X on the ground below the instrument.

While you are looking through the optical plummet, adjust the leveling screws until the image of the X is in the center of the reticle mark .

3. Rotate the alidade 180°.

If the marked image is in the same position in the center of the reticle mark, no adjustment is required.

4. If the image is not in the same position, adjust the optical plummet:
  - a. Use the supplied hexagonal wrench to turn the adjustment screws until the image of the X is in Position P. Position P is the center point of the line connecting the X and the center of the reticle mark .
  - b. Repeat from Step 2.

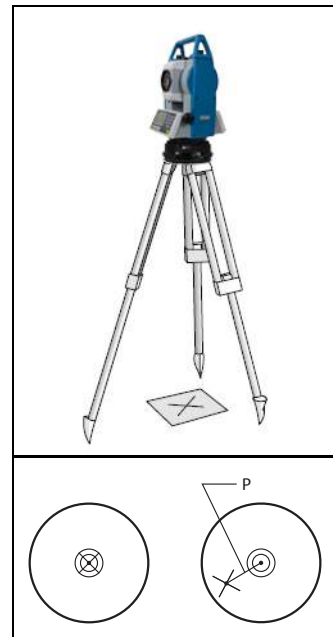

# Zero point errors of vertical scale and horizontal angle corrections

## Checking

1. Set up the instrument on the tripod.
2. Follow the leveling procedures described in Leveling, page 29.
3. Flip the telescope to the Face-1 position.
4. Sight a target that is within 45° of the horizontal plane.
5. Read the vertical angle from the VA1 field in the Basic Measurement screen.
6. Rotate the instrument 180° and flip the telescope to the Face-2 position.
7. Read the vertical angle from the VA2 field.
8. Add the two vertical angles together, VA1 + VA2.
  - No adjustment is required if the zero reference for vertical angles (VA zero setting) is set to Zenith, and VA1 + VA2 equals 360°.
  - No adjustment is required if the zero reference for vertical angles (VA zero setting) is set to Horizon, and VA1 + VA2 is either 180° or 540°.
  - An adjustment is required if VA1 + VA2 is not one of the values listed above.

**Note** – The difference between the vertical angle reading the relevant angle (either 360° for Zenith, or 180° or 540° for Horizon) is called the **altitude constant**.

## Adjusting

1. From the main menu, press **[7]** (or press **[v]** and **[REC/ENT]**) to select *Adjust*.

Menu	
1. Job	6. 1 Sec.
2. Cogo	7. Adjust
3. Set	8. Time
4. Data	9. Format
5. Comm	10. Info

The *Adjustments* menu appears.

2. Press **[2]** (or press **[v]** and **[REC/ENT]**) to select *Collimation*.

Adjustments	
1. VO Adjustments	
2. Collimation	
3. Inst. Constant	
4. VADJ Set	

The *Collimation* screen appears.

3. In Face1, precisely sight the target, and then press the **OK** softkey.
4. The system displays the message **Turn to F2**. Rotate the telescope, and sight the same target precisely in Face 2. Press the **OK** softkey.

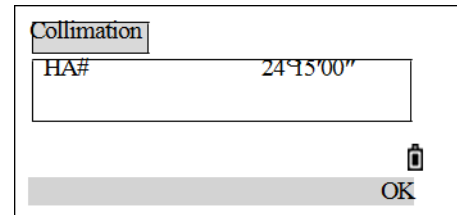

When complete, the screen displays the message **set** and then returns to the *Adjustment* menu.

## Checking the instrument constant

The instrument constant is a numerical value used to automatically correct for the displacement between the mechanical and electrical centers when measuring distances. The instrument constant is set by the manufacturer before the instrument is shipped. However, to ensure the highest operational accuracy, it is recommended that the instrument constant is checked several times a year.

To check the instrument constant, either compare a correctly measured base line with the distance measured by the EDM, or follow the procedure below.

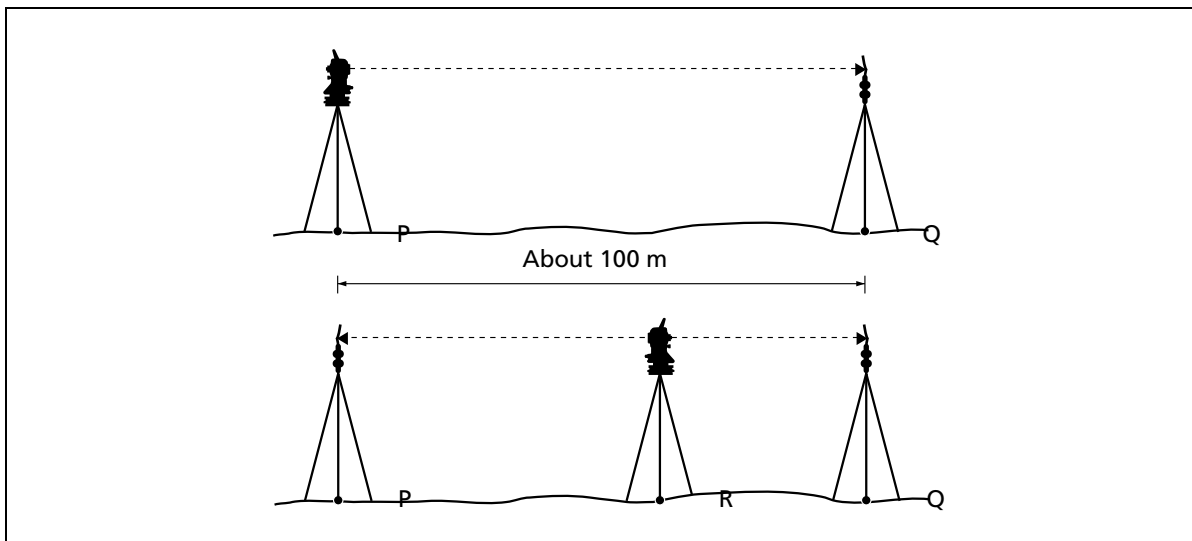

To check the instrument constant:

5. Set up the instrument at point P, in as flat an area as possible.
6. Set up a reflector prism at point Q, 100 m away from point P. Make sure that the prism constant is taken into account.
7. Measure the distance between point P and point Q (PQ).
8. Install a reflector prism on the tripod at point P.



9. Set up another tripod at point R, on the line between point P and point Q.
10. Transfer the total station to the tripod at point R.
11. Measure the distance from point R to point P (RP), and from point R to point Q (RQ).
12. Calculate the difference between the value of PQ and the value of RP + RQ.
13. Move the total station to other points on the line between point P and point Q.
14. Repeat Step 5 through Step 13 ten times or so.
15. Calculate the average of all the differences.

The error range is within 3 mm. If the error is out of range, contact your dealer.

## Checking the laser pointer

The total station uses a red laser beam as a laser pointer. The laser pointer is coaxial with the line of sight of the telescope. If the instrument is well adjusted, the red laser pointer coincides with the line of sight. External influences such as shock or large temperature fluctuations can displace the red laser pointer relative to the line of sight.

1. On the center of a piece of paper, draw a target in the form of a vertical line and an intersecting horizontal line.
2. Set the target on a wall about 10 m (30 ft.) from the instrument and sight the instrument to the point of intersection of the two lines on the target.
3. With the instrument powered on, turn on the laser pointer.
4. Check that the center of the laser pointer coincides with the point of intersection.
5. If this is not the case, the instrument should be taken to an authorized service center for adjustment.

# Specifications

## In this chapter:

- Distance measurement
- Angle measurement
- Telescope
- Tilt sensor
- Communications
- Power
- General
- Environmental

## Distance measurement

<b>Range with specified prisms (Good conditions)<sup>1</sup></b>	
Single prism	2.5 m to 4,000 m (8.2 ft to 13,123 ft)
Reflectorless <sup>2</sup>	500 m (1,640 ft)
Shortest possible range	1.0 m (3.3 ft)
<b>Accuracy (Precise mode) ISO 17123-4</b>	
Prism	$\pm(2+2 \text{ ppm} \times D)$ mm
Reflectorless <sup>3</sup>	$\pm(3+2 \text{ ppm} \times D)$ mm
<b>Measuring intervals<sup>4</sup></b>	
Fine	0.3 sec.
Normal	0.2 sec.

<sup>1</sup>Good conditions (good visibility, overcast, twilight, underground, low ambient light).

<sup>2</sup>Measuring distance may vary depending on targets and measuring conditions.

<sup>3</sup>Accuracy 1.0 m to 5.0 m (3.3 ft to 16.4 ft) is  $\pm 8$  mm.

<sup>4</sup>Measuring time may vary depending on measuring distance and conditions. For the initial measurement, it may take a few more seconds.

## Angle measurement

<b>Accuracy (ISO17123-3)</b>	
Horizontal and vertical	2" / 0.6 mgon
	5" / 1.5 mgon
<b>Reading system</b>	Absolute encoder
<b>Circle diameter</b>	79 mm (3.1 in)
<b>Horizontal/Vertical angle</b>	Diametrical
Minimum increment	Degree: 1" or 5"
	Gon: 0.2 or 1 mgon
	MIL6400: 0.005 or 0.02 mil

## Telescope

<b>Tube length</b>	154 mm (6.0 in.)
<b>Image</b>	Erect
<b>Magnification</b>	30 ×
<b>Effective diameter of objective</b>	45 mm (1.8 in.)
<b>EDM diameter</b>	50 mm (2.0 in.)
<b>Field of view</b>	1°30'
<b>Resolving power</b>	3.0"
<b>Minimum focusing distance</b>	1.0 m (3.3 ft)
<b>Laser pointer</b>	Coaxial Red Light

## Tilt sensor

<b>Type</b>	Dual-axis
<b>Method</b>	Liquid-electric detection
<b>Compensation range</b>	±3.0'

## Communications

<b>Communication ports</b>	1 × serial (RS-232C)
<b>Data interface</b>	SD card, mini USB

## Power

<b>Internal Ni-MH battery</b>	2
<b>Output voltage</b>	6.0 V DC
<b>Operating time<sup>1</sup></b>	about 13 hours
<b>Charging time</b>	Full charge: 4 hours

<sup>1</sup>Battery life specification at 25 °C (77 °F). Operation time may be shorter in low temperatures or if the battery is not new.

## General

<b>Level vials</b>	2
Sensitivity of circular level vial	8' / 2 mm
Sensitivity of plate vial	30" / 2 mm
<b>Optical plummet</b>	
Image	Erect
Magnification	3x
Field of View	5°
Focusing range	0.3 m (1.0 ft) to ∞
<b>Display face 1 and face 2</b>	backlit, graphic LCD 160 x 90 pixels
<b>Point memory</b>	10,000 records
<b>Dimensions (W x D x H)</b>	160 mm x 150 mm x 340 mm (6.3 in x 5.9 in x 13.4 in)
<b>Weight (approx.)</b>	5.1 kg (11.3 lb)
<b>Battery</b>	0.2 kg (0.5 lb)
<b>Carrying case</b>	3.2 kg (7.0 lb)

## Environmental

<b>Operating temperature range</b>	-20 °C to +50 °C (-4 °F to +122 °F)
<b>Atmospheric correction</b>	
Temperature range	-40 °C to +60 °C (-40 °F to +140 °F)
Barometric pressure	400 mmHg to 999 mmHg 533 hPa to 1,332 hPa 15.8 inHg to 39.3 inHg
<b>Dust and water protection</b>	IP55

# Error Messages

## In this chapter:

- E001
- E002
- E003
- E004
- E005
- E006
- E007
- E031
- E032
- E033
- E034
- E035
- E036
- E037
- E038
- E33

## **E001**

Error opening the system parameter file.

If the format is invalid, send the instrument for repair.

## **E002**

Error opening file.

If the format is invalid, send the instrument for repair.

## **E003**

Error initializing files.

If the format is invalid, send the instrument for repair.

## **E004**

Error writing files.

If the format is invalid, send the instrument for repair.

## **E005**

Error reading files.

If the format is invalid, send the instrument for repair.

## **E006**

Error deleting files.

If the format is invalid, send the instrument for repair.

## **E007**

Error checking hardware

If the format is invalid, send the instrument for repair.

## E031

Angle error 1.

Shut off the instrument and then power on. If the error code appears again, send the instrument for repair.

## E032

Angle error 2.

Shut off the instrument and then power on. If the error code appears again, send the instrument for repair.

## E033

Angle error 3.

Shut off the instrument and then power on. If the error code appears again, send the instrument for repair.

## E034

Vertical angle error 4.

Shut off the instrument and then power on. If the error code appears again, send the instrument for repair.

## E035

Horizontal angle error 5.

Shut off the instrument and then power on. If the error code appears again, send the instrument for repair.

## E036

Horizontal angle error 6.

Shut off the instrument and then power on. If the error code appears again, send the instrument for repair.



## **E037**

Vertical angle error 7.

Shut off the instrument and then power on. If the error code appears again, send the instrument for repair.

## **E038**

Angle error 8.

Shut off the instrument and then power on. If the error code appears again, send the instrument for repair.

## **E33**

Problem with EDM

Send the instrument for repair.

# Design Road Line Data

**In this appendix:**

- Raw data
- Coordinate data
- Code list
- Horizontal line
- Vertical curve

# Raw data

This is the format of data transmitted from the instrument to the computer.

Record format: example of FOCUS 2 data

Data transferred to PC	Description
CO,FOCUS2 Raw data	The type of transmitted data
CO,SAMPLE1	File name
CO,Description	Job description
CO,Client	
CO,Comments	
CO,Downloaded 2007-03-02 22:40:59	Download date and time
CO,Software: Pre-install version:07.03.02	Software version number
CO,Instrument: FOCUS 2 S15101	Serial number of instrument
CO,Dist Units: Metres	Distance unit
CO,Angle Units: DDDMMSS	Angle unit
CO,Zero azimuth: North	AZ Zero azimuth
CO,VA: Zenith	VA Zero azimuth
CO,Coord Order: NEZ	Coordinate order
CO,HA Raw data: HA zero to BS	HA
CO,Projection correction: OFF	Projection correction
CO,C&R correction: ON	C&R correction
CO,Tilt Correction: OFF	Tilt correction
CO,SAMPLE1 <JOB> Created 2007-03-02 22:37:25	JOB creation time
MP,1,,10.000,10.000,1.000,VM	Manually entered coordinate record
MP,5,,50.000,50.000,5.000,MP	Record format: pointID, N/E,E/N, Z, Code
CO,Temp:20.0 C Press:1013.2 hPa Prism:-30mm 2007.03.02 22:38:26	Temperature, pressure, prism offset, date, time
ST,1,,5,,1.600,45.0000,0.0000	Station data record Record format: Station pointID, Backsight pointID, height of instrument, azimuth (AZ), horizontal angle (HA)
F1,5,1.800,1.999,176.5958,99.2715, 23:26:28	Result of backsight point F1 orientation Record format: pointID, target height, slope distance, horizontal angle, vertical angle, time
SS,2,1.800,1.088,359.5959,62.4302, 22:38:45,MA	Sideshot point measurement data Record format: pointID, target height, slope distance, HA, VA, code
MP,99,,20.000,3.000,6.000,	Manually entered coordinate record Record format: pointID, N/E,E/N, Z, Code
CO,Pt:100 SO deltas N: E: Z:-3.131	Comment containing Stakeout residuals
SO,,,1.800,1.089,5.0432,84.5528, 22:40:28,	Stakeout data record Record format: ,, , target height, slope distance, HA, VA, time

## Coordinate data

The format of uploaded/downloaded coordinate data is determined by the setting in the instrument. The coordinate record format can be either of the following:

- pointID, E, N, Z, code
- pointID, N, E, Z, code

```
101,994.890,1000.964,100.113,FOCUS2
102,993.936,1007.799,100.800,STN
103,998.515,1009.639,100.426,STN
104,1002.068,1002.568,100.342,STN
1001,1004.729,997.649,100.1153,PT
1002,1003.702,990.838,100.799,PT
1003,7911.990,990.358,100.403,PT
1004,997.311,998.236,100.354,PT
```

## Code list

The code list is a list of feature codes, stored in the instrument.

Each line in the list contains a serial number and a code, followed by a carriage return.

If the code content is not entered, the code value defaults to the value of the serial number. In the quick code function, the code can be input by entering the serial number.

Record format: serial number (quick code number), code

### Code list example

```
1, VEG
2, BDY
3, CL
4, ROAD
5, ROAD
6, PATH
7, DRAIN
8, CONTROL
9, DRAIN
10, UTILITY
11, UTILITY
```

## Horizontal line

Horizontal lines are transmitted from the computer to the instrument through line elements, including the initial definition. Included in the initial definition are the start point chainage and the coordinate of this point. Line elements include point, straight, arc, and transition curve.

Record format: (KEYWORD) nnn, nnn [, nnn].

START POINT	chainage, N, E
STRAIGHT	azimuth, distance
ARC	radius, arc length
SPIRAL	radius, length
PT	E, N[,A1,A2] (A1, A2: LENGTH)

### Example 1

```
START 1000.000, 1050.000, 1100.000
STRAIGHT 25.0000, 48.420
SPIRAL 20.000, 20.000
ARC 20.000, 23.141
SPIRAL 20.000, 20.000
STRAIGHT 148.300, 54.679
```

### Example 2

```
START 1000.000, 1050.000, 1100.000
PT 1750.000, 1300.000, 100.000, 80.800
PT 1400.000, 1750.000, 200.000
PT 1800.000, 2000.000
```

## Vertical curve

Vertical curve data is entered into the computer by point and chainage data. The vertical curve data should include the elevation and curve length. The curve length of the start point and the end point is zero.

Record format: Chainage, elevation, curve length

### Example

```
1000.000, 50.000, 0.000
1300.000, 70.000, 300.000
1800.000, 70.000, 300.000
2300.000, 90.000, 0.000
```

# Calculate Road Alignment

## In this appendix:

- Road alignment elements
- Calculating road alignment elements

The road alignment stake-out program can stake out the alignment elements including straight, arc, and transition curve.

Road alignment data can be uploaded from a computer or manually entered.

Road alignment data is managed by chainage.

# Road alignment elements

There are two ways to enter the alignment elements:

- Download from a computer.
- Manually enter them in the instrument.

## Enter the alignment data

Alignment element	Parameter
Straight	Bearing, Distance
Transition Curve	Radius, Length of Transition Curve
Arc	Radius, Length of Arc
PT	N, E, radius, A1, A2

**Note** – When downloading from a computer or selecting the PT option, the parameters do not have to be calculated.

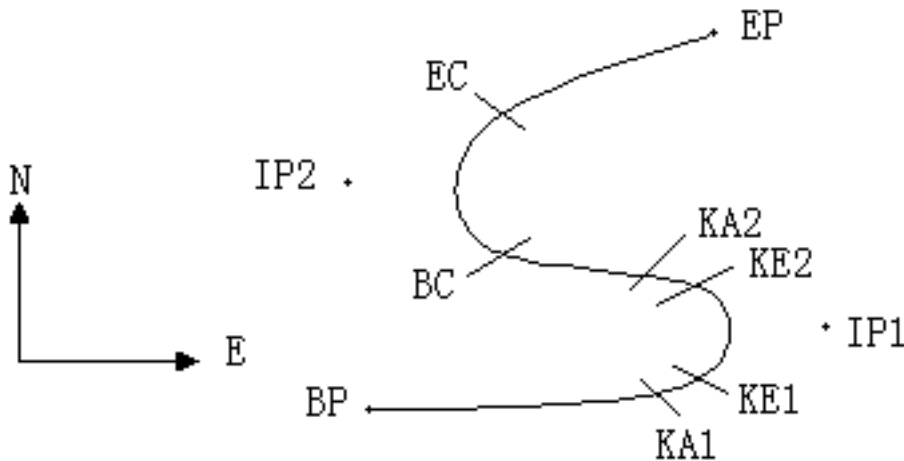

PT	North (N)	East (E)	Radius (R)	Transition curve A1	Transition curve A2
BP	1100.000	1050.000			
IP1	1300.000	1750.000	100.000	80.000	80.000
IP2	1750.000	1400.000	200.000	0.000	0.000
EP	2000.000	1800.000			

Example:

1. From the **PRG** (*Program*) menu, select *Roads / Def Al.*
2. Enter the following data:

Field	Value
Chainage	0
N	1100.000
E	1050.000

3. Press **REC/ENT** and then press **F4** (PT).
4. Enter the following data:

Field	Value
N	1300.000
E	1750.000
R	100.000
A1	80.000
A2	80.000

5. Enter the following data:

Field	Value
N	1750.000
E	1400.000
R	200.000
A1	0.000
A2	0.000

6. Enter the following data:

Field	Value
N	2000.000
E	1800.000
R	0.000
A1	0.000
A2	0.000



The data transmitted to the computer is formatted as follows:

```
START 0.000, 1050.000, 1100.000 CRLF
PT 1750.000, 1300.000, 100.000, 80.000, 80.000 CRLF
PT 1400.000, 1750.000, 200.000, 0.000, 0.000 CRLF
PT 1800.000, 1800.000, 2000.000 CRLF
```

## Calculating road alignment elements

### Length of transition curve

$$L_{1,2} = A_{1,2}^2 / R$$

$L_{1,2}$ : Length of clothoid

$A_{1,2}$ : Parameter of clothoid

R: Radius

$$L_1 = A_1^2 / R = 80^2 / 100 = 64\text{m}$$

$$L_2 = A_2^2 / R = 80^2 / 100 = 64\text{m}$$

## Deflection angle

$$\tau_1 = \frac{64^2}{2 \cdot 80^2} = 0.32 \text{ rad} = 0.32 \frac{180}{\pi} = 18^\circ 20' 06'' \text{ deg}$$

$$\therefore (\tau_1 = -\tau_2)$$

$$\tau = \frac{L^2}{2A^2}$$

## Transition coordinates

$$N = A \cdot \sqrt{2\tau} \left( 1 - \frac{\tau^2}{10} + \frac{\tau^4}{216} - \frac{\tau^6}{9360} \dots \right)$$

$$E = A \cdot \sqrt{2\tau} \left( \frac{\tau}{3} - \frac{\tau^3}{42} + \frac{\tau^5}{1320} - \frac{\tau^7}{7560} \dots \right)$$

For example:

$$\begin{aligned} N &= 80 \cdot \sqrt{2 \cdot 0.32} \left( 1 - \frac{0.32^2}{10} + \frac{0.32^4}{216} - \frac{0.32^6}{9360} \dots \right) \\ &= 64 \left( 1 - \frac{0.1024}{10} + \frac{0.01048576}{216} - \frac{0.001073741824}{9360} \dots \right) \end{aligned}$$

$$= 64(1 - 0.01024 + 0.00485 - 0.000114) \approx 63.348$$

$$= 64 * 0.98981$$

$$= 63.348$$

Similarly, the value of E is:

$$E = 80 \cdot \sqrt{2 \cdot 0.32} \left( \frac{0.32}{3} - \frac{0.32^3}{42} + \frac{0.32^5}{1320} - \frac{0.32^7}{7560} \dots \right)$$

$$= 64(0.10666667 - 0.00078019 + 0.0000025 - 0) \approx 6.777$$

$$= 6.777$$

This is an example of a symmetrical spiral transition: N1 = N2, E1 = E2.

## Shift value $\Delta R$

$$\Delta R = E - R(1 - \cos\tau)$$

$$\begin{aligned}\Delta R &= 6.777 - 100(1 - \cos 18^\circ 20' 06'') \\ &= 1.700\end{aligned}$$

Symmetrical spiral transition:  $\Delta R_1 = \Delta R_2$

## Spiral transition coordinates

$$N_m = N - R \sin\tau = 63.348 - 100 \sin 18^\circ 20' 06'' = 31.891$$

Symmetrical spiral transition:  $N_{m1} = N_{m2}$

## Tangent distance

$$LA = 111^\circ 55' 47'', \quad \csc = \frac{1}{\sin LA}, \quad \cot = \frac{1}{\tan LA}$$

$$D_1 = R \tan\left(\frac{LA}{2}\right) + \Delta R_2 \csc(LA) - \Delta R_1 \cot(LA) + N_{m1}$$

$$LA = 111^\circ 55' 47'', \quad \csc = \frac{1}{\sin LA}, \quad \cot = \frac{1}{\tan LA}$$

In this example:

$$\begin{aligned}D_1 &= 100 \times \tan(111^\circ 55' 47''/2) + 1.7(1/\sin 111^\circ 55' 47'') - 1.7(1/\tan 111^\circ 55' 47'') + 31.891 \\ &= 148.06015 + 1.8326 + 0.6844 + 31.891 \\ &= 182.468\end{aligned}$$

$$D_1 = D_2$$

## Coordinate KA1

$$N_{KA1} = N_{IP1} - D_1 \cdot \cos \alpha_1$$

$$E_{KA1} = E_{IP1} - D_1 \cdot \sin \alpha_1$$

Bearing from BP to IP1,  $\alpha_1 = 74^\circ 03' 16.6''$  :

$$N_{KA1} = 1300 - 182.468 \cdot \cos 74^\circ 03' 16.6'' = 1249.872 \text{ m}$$

$$E_{KA1} = 1750 - 182.468 \cdot \sin 74^\circ 03' 16.6'' = 1574.553 \text{ m}$$

## Arc length

$$L = R(LA - (t_1 + t_2))$$

$$= R(111^\circ 55' 47'' - (2 \times 18^\circ 20' 06''))$$

$$= 131.353 \text{ m}$$

$$= 100 \left( 75^\circ 15' 35'' \cdot \frac{\pi}{180^\circ} \right)$$

## Coordinate KA2

$$N_{KA2} = N_{IP1} - D_2 \cdot \cos \alpha_2$$

$$E_{KA2} = E_{IP1} - D_2 \cdot \sin \alpha_2$$

Bearing from IP1 to IP2,  $\alpha_2 = 322^\circ 07' 30.1''$ :

$$N_{KA2} = 1300 - (-182.468) * \cos 322^\circ 07' 30.1'' = 1444.032 \text{ m}$$

$$E_{KA2} = 1750 - (-182.468) * \sin 322^\circ 07' 30.1'' = 1637.976 \text{ m}$$

## Coordinates BC, EC which is ARC (IP1,IP2,EP)

Arc length  $CL = R \cdot IA$

When  $IA = 95^\circ 52' 11''$  :

$$CL = 200 \times 95^\circ 52' 11'' \times \frac{\pi}{180^\circ} = 334.648 \text{ m}$$

Tangent length:

$$TL = R \cdot \tan\left(\frac{IA}{2}\right) = 200 \times \tan(95^\circ 52' 11'' / 2) = 221.615 \text{ m}$$

Each coordinate is calculated as follows:

$$N_{BC} = N_{IP2} - TL \cdot \cos \alpha_2$$

$$E_{BC} = E_{IP2} - TL \cdot \sin \alpha_2$$

$$N_{EC} = N_{IP2} - TL \cdot \cos \alpha_3$$

$$E_{EC} = E_{IP2} - TL \cdot \sin \alpha_3$$

where:

$$\alpha_2 \text{ (bearing from IP1 to IP2)} = 322^\circ 07' 30.1''$$

$$\alpha_3 \text{ (bearing from IP2 to EP)} = 57^\circ 59' 40.6''$$

the coordinates values are:

$$N_{EC} = 11750 - 221.615 * \cos 322^\circ 07' 30.1'' = 1575.068 \text{ m}$$

$$E_{BC} = 1400 - 221.615 * \sin 322^\circ 07' 30.1'' = 1536.058 \text{ m}$$

$$N_{EC} = 1750 - (-221.615) * \cos 57^\circ 59' 40.6'' = 1867.456 \text{ m}$$

$$E_{EC} = 1400 - (-221.615) * \sin 57^\circ 59' 40.6'' = 1587.929 \text{ m}$$

The calculated results are displayed below:

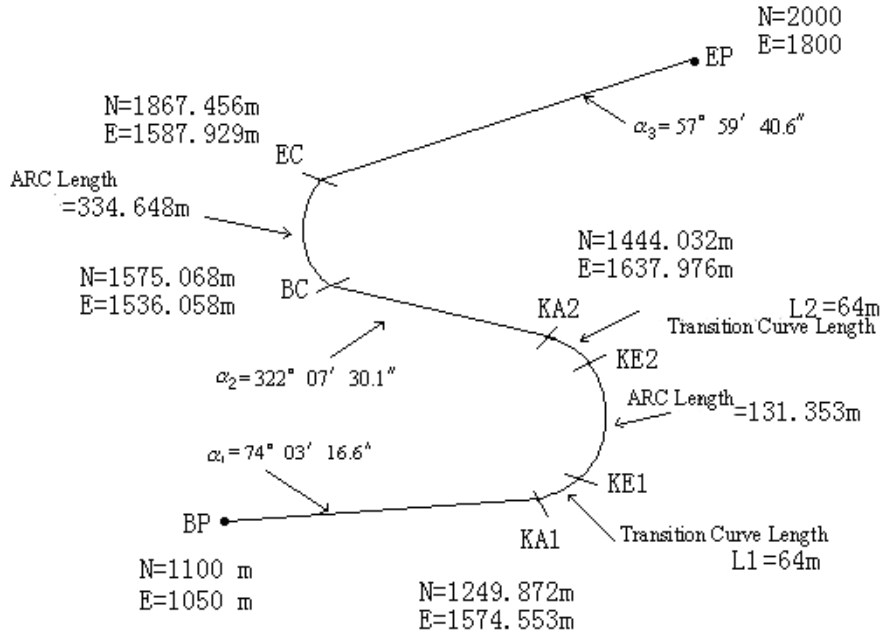

The coordinates and the distances are calculated as below.

Straight line BPKA1:

$$BPKA1 = \sqrt{(1249.872 - 1100.000)^2 + (1574.553 - 1050)^2} = 545.543 \text{ m}$$

Straight line KA2BC:

$$KA2BC = \sqrt{(1575.068 - 1444.032)^2 + (1536.058 - 1637.976)^2} = 166.005 \text{ m}$$

Straight line ECEP:

$$ECEP = \sqrt{(2000 - 1867.456)^2 + (1800 - 1587.929)^2} = 250.084 \text{ m}$$

Start point coordinate (BP):

N	1100.000 m
E	1050.000 m

Straight line (between BP and KA):

Bearing	74°03'16.6''
Distance	545.543 m

Transition clothoid (between KA1 and KE1):

Radius	-100 m ("-"sign is the curve turns left toward the end point)
Length	64 m

ARC (between KE1 and KE2):

Radius	-100 m ("-"sign is the curve turns left toward the end point)
Length	131.354 m

Transition (Between KE2 and KA2):

Radius	-100 m ("-"sign is the curve turns left toward the end point)
Length	64 m

Straight line (between KA2 and BC):

Bearing	322°07'30.1"
Distance	166.004 m

Arc (between BC and EC):

Radius	200 (without sign is the curve turns right toward the end point)
Length	334.648 m

Straight line (between EC and EP):

Bearing	57°59'40.6"
Distance	250.084 m